

APSCON / APSCON UNMANNED 2026

July 13 - 17, 2026

Broward County Convention Center
Fort Lauderdale, FL

Dear Exhibitor:

As the Official General Service Contractor, we would like to welcome you to **APSCON / APSCON UNMANNED 2026**.

We have, along with Show Management, compiled this Exhibitor Services Manual to provide you with all of the necessary forms and vital information that you will need for a successful exposition experience.

In order to qualify for discount prices where available, please take time to review this manual now. To receive the discount prices your order(s) along with full payment must be received by the date indicated on the particular form. Please do not miss out on this opportunity to secure discounted prices. The savings offered to you are substantial.

Should you have any questions regarding any of the services or need assistance in planning your exhibit, please do not hesitate to contact our customer service department at 253 437 0031 or via email at operations@levyexpo.com. We will be happy to assist you in any way possible to ensure that you have a successful experience at **APSCON / APSCON UNMANNED 2026**.

Thank you and we look forward to servicing your needs at **APSCON / APSCON UNMANNED 2026** in **Fort Lauderdale, FL**.

Sincerely,

Levy Exposition Services, Inc.



APSCON / APSCON UNMANNED 2026

QUICK FACTS

SERVICE CONTRACTOR CONTACT: LEVY EXPOSITION SERVICES INC.
14900 Interurban Avenue S., Suite 271
Seattle, WA 98168
T: 253 437 0031 F: 253 437 0032 E: operations@levyexpo.com

LOCATION: Broward County Convention Center
1950 Eisenhower Blvd
Fort Lauderdale, FL 33316

EXHIBITOR MOVE-IN: Monday, July 13, 2026 8:00 am – 5:00 pm
Aircraft Fly In (as scheduled by APSA safety) 8:00 am - Completion
Tuesday, July 14, 2026 8:00 am – 5:00 pm
Wednesday, July 15, 2026 8:00 am – 2:00 pm

EXHIBITION DATES: Wednesday, July 15, 2026 5:00 pm – 8:00 pm (*Opening Reception*)
Thursday, July 16, 2026 10:30 am – 4:00 pm
Friday, July 17, 2026 10:00 am – 2:00 pm

EXHIBITOR MOVE-OUT: Friday, July 17, 2026 2:00 pm – 9:00 pm
Saturday, July 18, 2026 8:00 am – 12:00 pm
****Please note that all exhibit materials must be removed from the exhibit Facility by 12:00 pm on Saturday, July 18, 2026.****

BOOTH EQUIPMENT: Each 10' x 10' booth space includes the following:

- 8' high drapery backwall – black
- 3' high drapery sidewall – black
- 1 - 7" x 44" booth identification sign

If you require additional furnishings or services please complete and return the appropriate enclosed order form(s).

AISLE CARPET: The aisles will be carpeted in the color salt & pepper (black and white speckle).

CEILING HEIGHT: The ceiling height in the exhibit hall is 34 feet. Check with Show Management if your booth is close to the Exhibit Hall entrance.

DISCOUNT PRICE DEADLINE: In order to receive the discount rates listed on the enclosed order forms, your **PAID** order is to be received by **June 22, 2026**.

LEVY ONLINE ORDERING (LOLO): The online ordering link and instructions will be sent via email to all exhibitors. Please provide your correct contact information to the show organizer to ensure you receive all necessary show information.

ELECTRICAL & PLUMBING SERVICES: Edlen is the official service provider for Electrical & Plumbing services. To order services, please see **page 68**.

CONVENTION CENTER SERVICES: The Broward County Convention Center is the official service provider for Internet services. To order services, please follow the link below:
<https://exhibitors.venueops.com/exhibitorStore/account-1347-A/exhibition-7907-A/category/category-3617-A>

AUDIO VISUAL SERVICES: AVPG is the official service provider for Audio Visual services. To order services, please see **pages 69 - 70**.

CATERING SERVICES:

The Broward County Convention Center is the official service provider for Catering services. To order services, please see **pages 71 - 99**.

SHIPPING:

Please refer to the Material Handling order form in this manual for further information and associated costs.

All **ADVANCE WAREHOUSE** shipments should arrive between June 8, 2026 – July 6, 2026. Shipments arriving before or after these dates will incur an early/late surcharge.

Shipments sent to the advance warehouse should be consigned as follows: (Labels are provided in the Material Handling Section of the manual)

APSCON 2026
Exhibiting Company Name
Booth # ____
Levy Exposition Services, Inc.
c/o Liberty CFS
12250 NW 28th Ave
Miami, FL 33167

All **DIRECT** shipments should not arrive prior to 8:00 am on **Monday, July 13, 2026**. Shipments arriving prior to this time will be refused.

Direct shipments should be consigned as follows: (Labels are provided in the Material Handling section of manual)

APSCON 2026
Exhibiting Company Name
Booth # ____
Broward County Convention Center
c/o Levy Exposition Services, Inc.
1950 Eisenhower Blvd
Fort Lauderdale, FL 33316

DISMANTLE AND MOVE-OUT INFORMATION:

All exhibitor materials **MUST** be removed from the facility by 12:00 pm on Saturday, July 18, 2026. To ensure that all exhibitor materials are removed by this time, please have your carrier check in no later than 9:00 am on Saturday, July 18, 2026. In the event that your carrier does not check-in by this time, your shipment will be rerouted via the official carrier, Liberty CFS NV, Inc.

POST SHIPPING PAPERWORK:

Our customer service center will have outbound bills of lading and shipping labels for your convenience. Please note that Levy Exposition Services Bills Of Lading's (BOLs) **MUST** be filled out and turned into the service center once your materials are packed for all outbound shipments.

It is vital that your carrier knows your company name and booth # when you make your outbound shipping arrangements. Additionally, if your carrier plans to use a freight forwarding company to pick up your shipment(s), you **MUST** include this company's name as well as the actual shipping company's name on the bill of lading that you fill out. In the event someone other than the company listed on your outbound bill of lading arrives to pick up your shipment, it will be rerouted via the official show carrier.

ONLINE ORDERING INSTRUCTIONS

We are pleased to offer online ordering for **APSCON / APSCON UNMANNED 2026**. This system is designed to assist in fulfilling your exposition needs simply, conveniently and securely.

Our online ordering links are unique to each exhibitor and are generated when exhibitors are imported to our online system. This creates a streamlined experience for exhibitors and eliminates the need to create a username and password.

1. You will receive an email from Levy Exposition Services with a copy of the PDF Exhibitor Kit and your account specific online ordering link. →
NOTE: If you do not receive your email, please email agaudet@levyshow.com and you will be sent one directly.



2. Once you have accessed the online ordering portal, you will be directed to the Welcome Page where you can access the Exhibitor Kit, Show Facts and other ancillary service forms. To begin online ordering, you can click the red “Order Booth Services” button. →
3. After making your service or rental selections, click the “Add to Cart” button. Once you have finished adding all items or services to your cart, click on the “My Cart/Orders” tab on the menu at the top of the page to view your order.
4. To complete your purchase click on the “Proceed to Checkout” button.
5. Complete your billing details and enter your credit card information to confirm and complete the order.
NOTE: Alternatively, to expedite the check out process, you may enter your card details before online shopping by clicking the “My Profile/CC” tab on the menu at the top of the page, then click “Credit Cards” and fill out the required information.

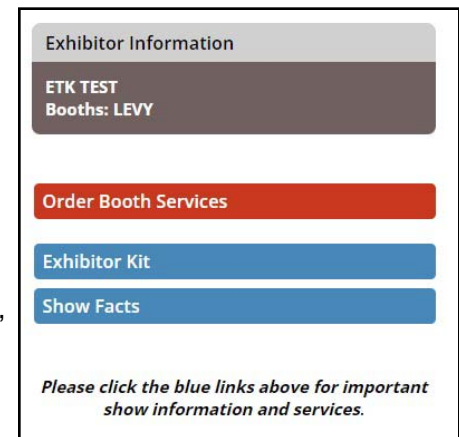

OTHER HELPFUL INFORMATION:

1. To find your username and password, please click on the “My Profile/CC” tab on the menu at the top of the page.
2. To access and view your invoice(s), please click on the “My Invoice” tab on the menu at the top of the page.

SAFETY RULES

Exhibitors must provide adequate space within the exhibit to allow for the comfort and safety of persons watching demonstrations and/or placing orders. Each exhibitor is responsible for keeping the aisles near their booth free of congestion which may be caused by such demonstrations and/or order placement.

Aisles **MUST** remain free and clear of all obstructions. If chairs are being used as part of your exhibit, they **MUST** remain inside your booth space. Chairs in the aisle constitute a violation of fire codes and are also considered a booth violation.

Do not run electrical cords or position displays and/or product in such a way as to pose a safety hazard for attendees and company personnel who will traffic into booth areas.

Do not store cardboard cartons or packing materials in booth areas, as this is a violation of fire codes and poses a safety hazard.

Do not place product samples, whether on tables or free-standing displays, at the edge of the aisle, or in the case of an island booth, on shelving units on an outside wall. All portions of an Exhibitor's display must be contained within his/her assigned booth space, including chairs placed at the edge of an aisle.

At the close of the exhibit hall, please keep clear of all aisles including exhibit material and/or product. During the first two or three hours after the close of the exhibit hall, there is ample traffic in the aisles including but not limited to forklift traffic returning empty containers.

SHOW SITE WORK RULES IN MIAMI, FLORIDA

To assist you in planning for your participation in the show, we are certain you will appreciate knowing in advance that Levy labor will be required for certain aspects of your exhibit handling. To help you understand the show site work rules, we ask that you read the following.

LABOR

Union exhibit labor claims jurisdiction for the installation, dismantling and cleaning of prefabricated displays when this work is done by persons other than fulltime company personnel. Union Labor is available to assist in the building and dismantling of exhibit booths. The Union's jurisdiction does not cover the placement of your products on display, the opening of cartons containing your products, nor the performance, testing, maintenance, or repairs of your products.

Any labor services that are required beyond what your regular full time employees can provide may be arranged at the established rates, using the enclosed order forms.

MATERIAL / FREIGHT HANDLING JURISDICTION

The Union exhibit labor have jurisdiction over all unloading and reloading of materials. The Union also has jurisdiction over all material handling equipment, including all dollies and hand trucks. It also has the authority of the unloading, uncrating, unskidding, leveling, painting, and assembly of machinery and equipment and the reverse process.

An exhibitor may "hand carry" material provided they do not use any material handling equipment to assist them. When exhibitors choose to hand carry material, they may not be permitted access to the loading dock/freight door areas. Items must be carried by hand, by one person.

Vehicles must not be left unattended at the loading areas. Any unattended vehicles will be towed at the owner's expense.

GRATUITIES

Levy employee(s) are paid an excellent wage, and tipping is not an accepted company policy. Levy requests that exhibitors do not tip its employees by giving money, merchandise, or other special consideration for services rendered. Any attempts to solicit a gratuity by an employee for any service, should be reported immediately to a supervisor of Levy.

IN GENERAL

Exhibitors do not have to respond to grievances or complaints from union and trade personnel concerning work. Exhibitors do not have to respond to grievances or complaints from union and trade personnel concerning work jurisdictions. Please refer all such disputes and questions to a Levy management representative immediately.

SAFETY

The safety of everyone working in the hall is of our utmost concern at all times. Standing on chairs, tables, and other rental furniture is prohibited. This furniture is not engineered to support your standing weight. Levy Exposition Services Inc. cannot be held responsible for injuries or falls caused by the improper use of this furniture. If assistance is required in assembling your booth, please order labor on the Labor Order Form included in this manual, and the necessary ladders and tools will be provided.

EXHIBIT CONSTRUCTION GUIDELINES SUMMARY

The Exhibitor's responsibility can be summed up as simply: **"Be a good neighbor!"** All exhibitors are equal regardless of size and should be given an equal opportunity, within reason, to present their product in the most effective manner to the audience.

STANDARD BOOTH

Linear Booths have only one side exposed to an aisle and are generally arranged in a series along a straight line. They are also called "in-line" booths.

Dimensions: Linear Booths are most commonly ten feet (10') wide and ten feet (10') deep, i.e. 10'x10'. A maximum back wall height limitation of height feet (8') is generally specified.

Use of Space: Regardless of the number of Linear Booths utilized, (e.g. 10'x20', 10'x30', 10'x40', etc.) Display materials should be arranged in such a manner so as not to obstruct sight lines of neighboring exhibitors.

The maximum height of eight feet (8') is allowed only in the rear half of the booth space, with a four-foot (4') height restriction imposed on all materials in the remaining space forward to the aisle.

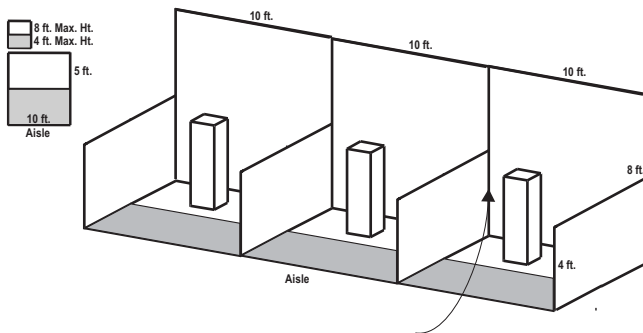

One or more standard 10'x10' units in a straight line.

Note: Booth drape is set at 8 ft max.

Display fixtures over 4 ft high must be confined to that area that is at least 5 ft from the aisle line.

ISLAND BOOTH

An Island Booth is any size booth exposed to aisles on all four sides.

Dimensions: An Island Booth is 20'x30' or larger, although it may be configured differently.

Use of Space: The entire cubic content of the space may be used up to the maximum allowable height, which is usually sixteen feet (16'), including signage.

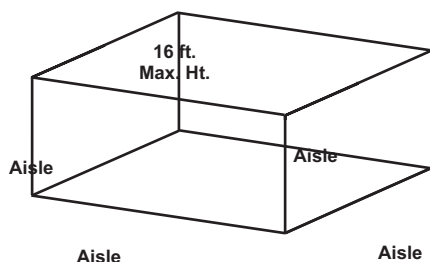

Please note that the ceiling height in the Exhibit Hall is 34 feet.

HANGING SIGN BOOTH

An exhibit component suspended above an exhibit of four or more standard units back-to-back with an aisle on at least three sides for the purpose of displaying graphics or identification.

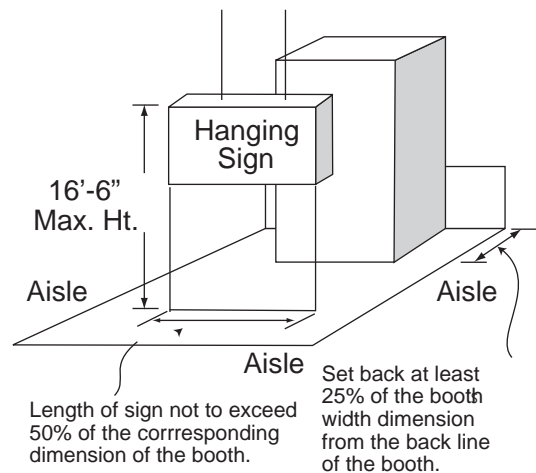

All overhead hanging must be assembled, installed, and removed by Levy. Please complete the enclosed Labor Order Form for labor to assemble your hanging sign.



Fax: 253 437 0032
 14900 Interurban Avenue South, Suite 271
 Seattle, WA
 USA 98168
 Telephone: 253 437 0031
 E-mail: operations@levyexpo.com

APSCON / APSCON UNMANNED 2026
 July 13 - 17, 2026
 Broward County Convention Center
 Fort Lauderdale, FL

REQUEST FOR SET-UP BY NON-OFFICIAL CONTRACTOR

The unpacking, erection, assembling, dismantling, and packing of displays and equipment must be done by the correct type of labor. Levy Exposition Services Inc., the official contractor, will have skilled craftsmen available to assist Exhibitors. Arrangements for labor should be made through Levy Exposition Services in advance whenever possible. Official labor forms are included in the Exhibitor Service Manual.

Exceptions to the foregoing will be considered only in cases where permission has been requested in writing by the Exhibitor and **received by Levy Exposition Services Inc. no later than June 22, 2026.** Exceptions will be granted only if it will not interfere with or prejudice the orderly set-up, interim service, or dismantling of the Exposition. An exception will not be granted if it is inconsistent with the commitments made and obligations assumed by Management in any contract with service contractors or its lease with the **Broward County Convention Center.** For services such as electrical, plumbing, telephone, drayage, rigging and booth cleaning, no exception will be made, and the contractor designated by Management will be used.

All agents representing the Exhibitor must be fully identified by the official Management badge. All agents or representatives who are performing services other than the Exhibitor's own employees must provide Levy Exposition Services with **Certificates of Insurance naming Levy Exposition Services Inc., Airborne Public Safety Association, APSCON / APSCON UNMANNED 2026, and the Broward County Convention Center as additional insured's by June 22, 2026.** These Certificates of Insurance must include public liability and property damage insurance for at least \$1,000,000, and workmen's compensation insurance in accordance with local law.

Exhibitors wishing to use a contractor other than Levy Exposition Services Inc. to set up and dismantle their exhibits must fill out this form and return to us no later than June 22, 2026. If this form and the certificate of insurance from the non-official contractor is not received by June 22, 2026, your non-official contractor will be allowed to supervise only. All labor must then be hired from Levy Exposition Services Inc. for installation and dismantle of the exhibit.

**ORIGINAL CERTIFICATES ONLY
 PHOTOSTATS OR FACSIMILES WILL NOT BE ACCEPTED**

Name of Exhibiting Company: _____ Booth Number: _____

Contracting Company Name: _____

Contracting Company Address: _____

City: _____ State: _____ Zip: _____ Telephone: _____ Fax _____

Estimated Arrival at Show _____ Number of Workers: _____

Authorized By: _____ Title: _____
 (Sign & Print Name)

CARPET and DRAPE

Standard carpet color options



Blue

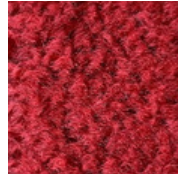

Red

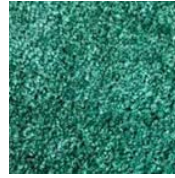

Teal



Grey



Burgundy

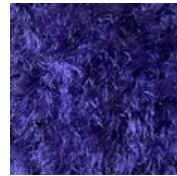

Purple



Black

Drape color options

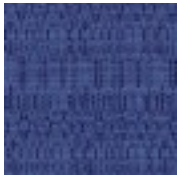

Blue



Red

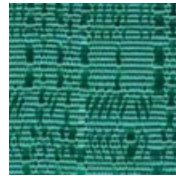

Teal

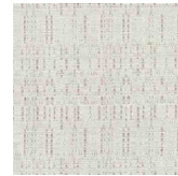

White

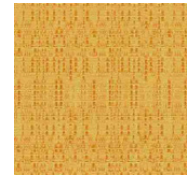

Gold



Black



Purple

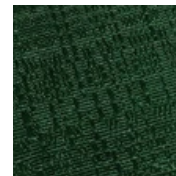

Green



Grey



Burgundy

**DISCLAIMER* Actual products and colors available may vary from the images shown. All products subject to availability*

Do you have questions?

We would be pleased to help. Contact us at: 253 437 0031

operations@levyexpo.com

www.levyexpo.com



Fax: 253 437 0032
 14900 Interurban Avenue South, Suite 271
 Seattle, WA
 USA 98168
 Telephone: 253 437 0031
 E-mail: operations@levyexpo.com

APSCON / APSCON UNMANNED 2026
July 13 - 17, 2026
 Broward County Convention Center
 Fort Lauderdale, FL

CARPET, DRAPE & COMPLEMENTS RENTAL ORDER FORM & INVOICE

COLORED CARPET SELECTIONS

Description	Discount Rate	Standard Rate	Total
Size - 10 ft. X 10 ft.	330.00	429.00	
10 ft. X 20 ft.	660.00	858.00	
10 ft. X 30 ft.	990.00	1,287.00	
10 ft. X 40 ft.	1,008.00	1,716.00	
Custom cut size. Calculate sq. ft. x price per sq. ft. Size _____ ft. x _____ ft. = _____ sq. ft.	6.10	7.93	

Blue Red Teal Grey Burgundy Purple Black

DRAPE (Includes installation and removal)

_____ lin. ft. of 3' high drape	\$10.00/ft	\$13.35/ft	
_____ lin. ft. of 8' high drape	\$14.25/ft	\$18.00/ft	

Blue Red Teal White Gold Black
 Purple Green Grey Burgundy

PLEASE NOTE: THE DRAPE PROVIDED WITH YOUR BOOTH SPACE CANNOT BE CHANGED WITHOUT SHOW MANAGEMENT APPROVAL.

CARPET OPTIONS

Description	Discount Rate	Standard Rate	Total
Carpet foam padding per sq. ft. Size _____ ft. x _____ ft. = _____ sq. ft.	2.50	3.75	
Poly covering per sq. ft. Size _____ ft. x _____ ft. = _____ sq. ft.	1.25	1.50	

COMPLEMENTS (Also see Specialty Accessories Form)

Quantity	Description	Discount Rate	Standard Rate	Total
	Waste basket	36.00	46.85	
	Chrome coat tree	156.50	203.50	
	Aluminum easel	62.00	80.50	
	Chrome sign holder 22" X 28"	156.50	203.50	
	Chrome stanchions	36.00	46.85	
	Velvet stanchion ropes - blue	36.00	46.85	

SPECIAL INSTRUCTIONS

EXHIBITOR INFORMATION

COMPANY _____

CONTACT _____

BOOTH#

COST SUMMARY

RATE ADJUSTMENT	(OFFICE USE ONLY)	
25% CANCELLATION FEE	(OFFICE USE ONLY)	
SUBTOTAL		
2.0% CREDIT CARD FEE		
7.0% SALES TAX		
TOTAL	US DOLLARS	

PLEASE REFER TO THE PAYMENT & CREDIT CARD CHARGE AUTHORIZATION FORM

ORDERS WILL NOT BE PROCESSED WITHOUT PAYMENT

STANDARD RATE will be applied to all orders not received and paid in full by **June 22, 2026**. We reserve the right to adjust orders calculated incorrectly.

A 25% CANCELLATION FEE will be applied to all orders received and then canceled. If full service has been provided then 100% of original fee will be applied.

CUSTOM CARPET

Deluxe Decorator 28oz. Carpet color options

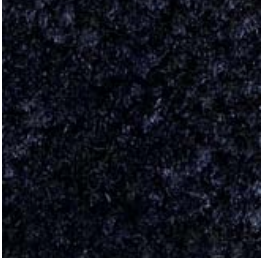

Black



Red



Nu Blue



Silver Cloud



Beige



Charcoal



Key Lime

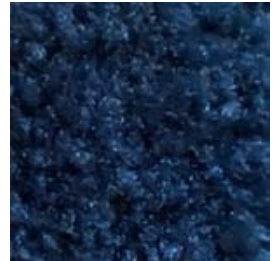

Navy



Cobalt



White

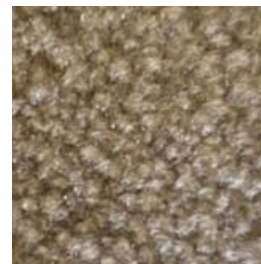

Silky Beige

**DISCLAIMER* Actual products and colors available may vary from the images shown. All products subject to availability*

Do you have questions?

We would be pleased to help. Contact us at: 253 437 0031

operations@levyexpo.com

www.levyexpo.com

CUSTOM CARPET ORDER FORM

Deluxe 28 oz. Carpet in a Variety of Decorator Colors to Enhance Your Exhibit

- | | | |
|---------------------------------------|--------------------------------------|-----------------------------------|
| <input type="checkbox"/> Black | <input type="checkbox"/> Red | <input type="checkbox"/> Nu Blue |
| <input type="checkbox"/> Silver Cloud | <input type="checkbox"/> Beige | <input type="checkbox"/> Charcoal |
| <input type="checkbox"/> Key Lime | <input type="checkbox"/> Navy | <input type="checkbox"/> Cobalt |
| <input type="checkbox"/> White | <input type="checkbox"/> Silky Beige | |

(CHECK BOX OF COLOR DESIRED)
 SAMPLES AVAILABLE UPON REQUEST

Rental includes installation and poly covering for protection and removal.
 Orders must be received by **June 22, 2026** to guarantee availability.

	DISCOUNT PRICE	STANDARD PRICE (late order)
Booth Size ____ ft. x ____ ft. = ____ sq. Ft. at	\$8.50 per sq. ft.	\$11.05 per sq. ft. =\$_____
Carpet Pad ____ ft. x ____ ft. = ____ sq. Ft. at	\$2.50 per sq. ft.	\$3.75 per sq. ft. =\$_____

NOTE: Include a floor plan if additional carpet is required to cover steps, skids and display fixtures. A quotation will be forwarded to you before we proceed

SPECIAL INSTRUCTIONS

EXHIBITOR INFORMATION

COMPANY	
CONTACT	BOOTH#

COST SUMMARY

RATE ADJUSTMENT	(OFFICE USE ONLY)	
CANCELLATION FEE	(OFFICE USE ONLY)	
SUBTOTAL		
2.0% CREDIT CARD FEE		
7.0% SALES TAX		
TOTAL	US DOLLARS	

PLEASE REFER TO THE PAYMENT & CREDIT CARD CHARGE AUTHORIZATION FORM

****ORDERS WILL NOT BE PROCESSED WITHOUT PAYMENT****

STANDARD RATE will be applied to all orders not received and paid in full by **June 22, 2026**. We reserve the right to adjust orders calculated incorrectly.

A 25% CANCELLATION FEE will be applied to all orders received then canceled. If full service has been provided then 100% of original fee will be applied.

TABLES & CHAIRS

Tables

All tables are available in the below options:

- Unskirted or Skirted
- 30" or 40" height
- 4', 6', or 8' lengths x 2' widths



4' x 2' skirted table



6' x 2' skirted table



8' x 2' skirted table

Skirt color options

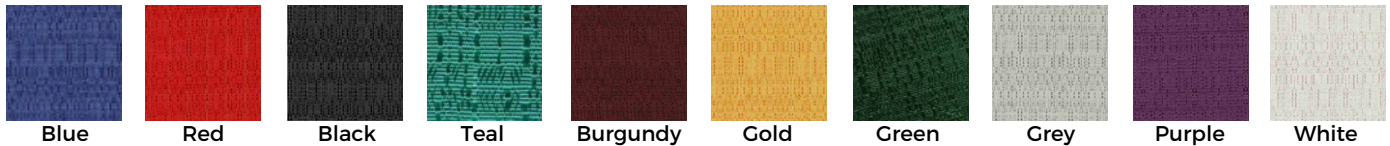

Blue

Red

Black

Teal

Burgundy

Gold

Green

Grey

Purple

White

Pedestal Tables

All pedestal tables are available in the below options:

- 30" diameter tops
- 30" or 40" high



40" high pedestal



30" high pedestal

Chairs



Fabric Sled Base Chair



Fabric Arm Chair



Fabric Highback Stool

**DISCLAIMER* Actual products and colors available may vary from the images shown. All products subject to availability*

Do you have questions?

We would be pleased to help. Contact us at: 253 437 0031

operations@levyexpo.com

www.levyexpo.com

TABLE AND CHAIR RENTAL ORDER FORM & INVOICE

TABLES

Description	Qty.	Discount Rate	Standard Rate	Total
 TABLES 30" HEIGHT				
8' x 2' Skirted		257.50	329.60	
6' x 2' Skirted		218.40	277.10	
4' x 2' Skirted		200.85	251.30	
Fourth side of table skirted		74.15	96.40	
Unskirted table <input type="checkbox"/> 8' <input type="checkbox"/> 6' <input type="checkbox"/> 4'		144.75	188.00	
<input type="checkbox"/> Blue <input type="checkbox"/> Red <input type="checkbox"/> Black <input type="checkbox"/> Teal <input type="checkbox"/> Burgundy <input type="checkbox"/> Gold <input type="checkbox"/> Green <input type="checkbox"/> Grey <input type="checkbox"/> Purple <input type="checkbox"/> White				

 TABLES 40" COUNTER HEIGHT				
8' x 2' Skirted		334.75	437.75	
6' x 2' Skirted		294.60	383.20	
4' x 2' Skirted		274.00	357.40	
Fourth side of table skirted		80.35	107.55	
Unskirted table <input type="checkbox"/> 8' <input type="checkbox"/> 6' <input type="checkbox"/> 4'		205.50	267.30	
<input type="checkbox"/> Blue <input type="checkbox"/> Red <input type="checkbox"/> Black <input type="checkbox"/> Teal <input type="checkbox"/> Burgundy <input type="checkbox"/> Gold <input type="checkbox"/> Green <input type="checkbox"/> Grey <input type="checkbox"/> Purple <input type="checkbox"/> White				

 PEDESTAL TABLE 30" DIAMETER				
30" Table height		179.00	232.70	
40" Counter height		219.00	284.70	

SPECIAL INSTRUCTIONS

EXHIBITOR INFORMATION

COMPANY

CONTACT

BOOTH#

CHAIRS

Description	Qty.	Discount Rate	Standard Rate	Total
 FABRIC SLED BASE CHAIR		152.00	200.20	
 FABRIC SLED BASE ARMCHAIR		172.00	223.60	
 FABRIC HIGHBACK STOOL		215.00	279.50	

COST SUMMARY

RATE ADJUSTMENT	(OFFICE USE ONLY)	
CANCELLATION FEE	(OFFICE USE ONLY)	
SUBTOTAL		
2.0% CREDIT CARD FEE		
7.0% SALES TAX		
TOTAL	US DOLLARS	

PLEASE REFER TO THE PAYMENT & CREDIT CARD CHARGE AUTHORIZATION FORM





ORDERS WILL NOT BE PROCESSED WITHOUT PAYMENT

STANDARD RATE will be applied to all orders not received and paid in full by **June 22, 2026**. We reserve the right to adjust orders calculated incorrectly.

A 25% CANCELLATION FEE will be applied to all orders received and then canceled. If full service has been provided then 100% of original fee will be applied.

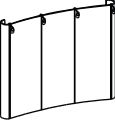
SPECIALTY ACCESSORIES RENTAL ORDER FORM & INVOICE

DISPLAY UNITS

Description	Qty.	Discount Rate	Standard Rate	Total
 FABRIC POSTER BOARD 4' x 8' grey fabric covered both sides <input type="checkbox"/> Horizontal (shown) <input type="checkbox"/> Vertical		144.00	187.00	
 POP-UP BOOTH 9'-6" x 7'-5" tall Velcro compatible Set of four lights <input type="checkbox"/> Blue <input type="checkbox"/> Grey <input type="checkbox"/> Black		2,173.50	2,825.50	
 BLACK UPRIGHT LITERATURE RACK 6 pockets for 8.5" x 11" material		160.00	208.00	
 PLEXIGLASS BROCHURE HOLDER 9" x 11" <input type="checkbox"/> Table top <input type="checkbox"/> Wall mount		46.00	59.80	
 ALUMINUM EASEL Fits sign sizes: 22" x 28" 24" x 36" 28" x 44"		60.00	78.00	
 CHROME SIGN HOLDER 22" x 28"		156.50	203.50	

ACCESSORIES

 TABLE TOP PLEXI DRAW BOX 12" x 12" x 12" tall		72.50	93.75	
 <input type="checkbox"/> CHROME CLOTHING STAND <input type="checkbox"/> CHROME BAG HOLDER		156.50	203.50	
 CHROME COAT TREE		156.50	203.50	

SPECIAL INSTRUCTIONS

EXHIBITOR INFORMATION

COMPANY _____

CONTACT _____ **BOOTH#** _____

COST SUMMARY

RATE ADJUSTMENT	(OFFICE USE ONLY)	
25% CANCELLATION FEE	(OFFICE USE ONLY)	
SUBTOTAL		
2.0% CREDIT CARD FEE		
7.0% SALES TAX		
TOTAL	US DOLLARS	

PLEASE REFER TO THE PAYMENT & CREDIT CARD CHARGE AUTHORIZATION FORM
****ORDERS WILL NOT BE PROCESSED WITHOUT PAYMENT****

STANDARD RATE will be applied to all orders not received and paid in full by **June 22, 2026**. We reserve the right to adjust orders calculated incorrectly.

A 25% CANCELLATION FEE will be applied to all orders received and then canceled. If full service has been provided then 100% of original fee will be applied.

RENTAL EXHIBITS

10' x 10' Hardwall Rental Exhibit Booths

All hardwall packages include the below:

- Aluminum structure
- White
- Header(s) - block letters - black (logo extra)
- 10' x 10' Carpet
- 30" pedestal table (x1)
- Fabric sledbase chairs (x2)

Package A1 Base



Package A2 Deluxe

- Base Package plus the below:
- 10" deep shelves (x2)
- 39" x 20" x 39" counter (x1)

Package B1 Base

- Curved header - block letters - black (logo extra)
- Curved front display counter



Package B2 Deluxe

- Base Package plus the below:
- Enclosed corner counter
- 10" deep shelves (x2)

Package C1 Base

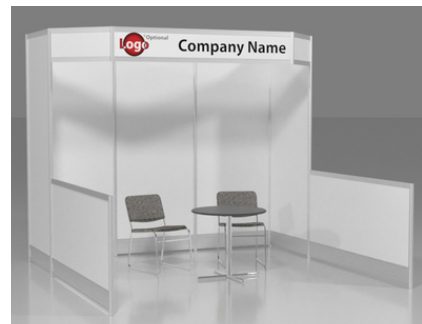

Package C2 Deluxe

- Base Package plus the below:
- 10" deep shelves (x2)
- 39" x 20" x 39" counter (x1)

Package D1 Base

- Oversized header - block letters - black (logo extra)
- 20" x 39" x 39" high built-in counters on backwall (x2)



Package D2 Deluxe

- Base Package plus the below:
- 10" deep shelves (x2)
- 39" x 20" x 39" counter (x1)

**DISCLAIMER* Actual products and colors available may vary from the images shown. All products subject to availability*

Do you have questions?

We would be pleased to help. Contact us at: 253 437 0031

operations@levyexpo.com

www.levyexpo.com

RENTAL EXHIBITS

10' x 20' Hardwall Rental Exhibit Booths

All hardwall packages include the below:

- Aluminum structure
- White
- Header(s) - block letters - black (logo extra)
- 10' x 20' Carpet
- 30" pedestal table (x1)
- Fabric sledbase chairs (x2)

Package E1 Base

- Straight headers (x2)

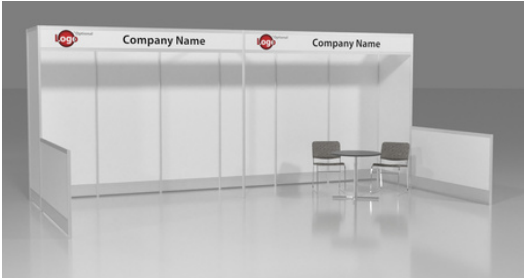

Package E2 Deluxe

- Base Package plus the below:
- 10" deep shelves (x2)
- 39" x 20" x 39" counter (x1)

Package F1 Base

- Straight header (x1)
- Angled header (x2)
- Storage area with drape door
- Front built-in corner counters (x2)



Package F2 Deluxe

- Base Package plus the below:
- Lockable door for storage area
- 39" x 20" x 39" counter (x2)

Package G1 Base

- Straight header (x1)
- 39" x 20" x 39" built-in counter (x1)

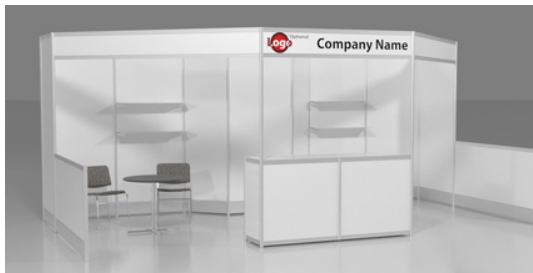
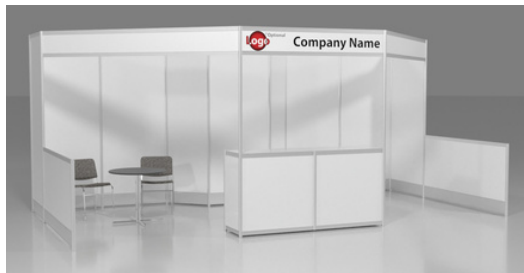

Package G2 Deluxe

- Base Package plus the below:
- 10" deep shelves (x4)

Package H1 Base

- Oversized curved header (x1)
- 39" x 20" x 39" built-in counters (x3)

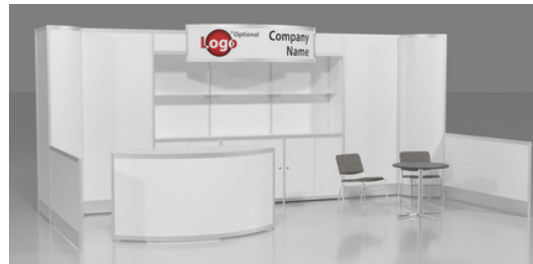

Package H2 Deluxe

- Base Package plus the below:
- 10" deep shelves (x3)
- 2m curved front counter (x1)

**DISCLAIMER* Actual products and colors available may vary from the images shown. All products subject to availability*

Do you have questions?

We would be pleased to help. Contact us at: 253 437 0031

operations@levyexpo.com

www.levyexpo.com



Fax: 253 437 0032
 14900 Interurban Avenue South, Suite 271
 Seattle, WA
 USA 98168
 Telephone: 253 437 0031
 E-mail: operations@levyexpo.com

APSCON / APSCON UNMANNED 2026
 July 13 - 17, 2026
 Broward County Convention Center
 Fort Lauderdale, FL

RENTAL EXHIBITS RENTAL ORDER FORM & INVOICE

10' x 10' BOOTH PACKAGES - *Please contact customer service for GRAPHIC UPGRADES*

Description: Base package includes: Aluminum structure, white hardwalls, booth header with company name in block lettering, carpet, 30" pedestal table, (2) fabric chairs, installation and dismantle.	Qty	Discount Rate	Standard Rate	Total
PACKAGE A1 Basic - Base package with header		4,796.00	6,235.00	
PACKAGE A2 Deluxe - Base package + (2) 10" deep shelves, (1) 39" x 20" x 39" counter		5,181.00	6,736.00	
PACKAGE B1 Basic - Corner base package booth with curved counter, 1 curved header sign		5,324.00	6,922.00	
PACKAGE B2 Deluxe - Base package + enclosed corner counter, (2) 10" deep shelves		5,621.00	7,308.00	
PACKAGE C1 Basic - Base package with header		4,950.00	6,435.00	
PACKAGE C2 Deluxe - Base package + (2) 10" deep shelves, (1) 39" x 20" x 39" counter		5,555.00	7,222.00	
PACKAGE D1 Basic - Base package with oversized header, (2) built-in back counters		5,714.00	7,494.00	
PACKAGE D2 Deluxe - Base package + (2) 10" deep shelves, (1) 39" x 20" x 39" counter		6,028.00	7,837.00	

10' x 20' BOOTH PACKAGES - *Please contact customer service for GRAPHIC UPGRADES*

Description: Base package includes: Aluminum structure, white hardwalls, booth header with company name in block lettering, carpet, 30" pedestal table, (2) fabric chairs, installation and dismantle.	Qty	Discount Rate	Standard Rate	Total
PACKAGE E1 Basic - Base package with headers		8,019.00	10,425.00	
PACKAGE E2 Deluxe - Base package + (2) 10" deep shelves, (1) 39" x 20" x 39" counter		8,725.00	11,342.00	
PACKAGE F1 Basic - Base package with headers, storage and drape door, (2) built-in counters		8,597.00	11,176.00	
PACKAGE F2 Deluxe - Base package + lockable door for storage, (2) 39" x 20" x 39" counters		9,653.00	12,549.00	
PACKAGE G1 Basic - Base package with header, (1) built-in counter		9,108.00	11,841.00	
PACKAGE G2 Deluxe - Base package + (2) 10" deep shelves		9,619.00	12,504.00	
PACKAGE H1 Basic - Base package with oversized curved header, (3) built-in back counters		10,197.00	13,257.00	
PACKAGE H2 Deluxe - Base package + (2) 10" deep shelves, (1) curved front counter		10,994.00	14,292.00	

OPTIONS & INFORMATION

HARDWALL PANEL (non fabric) SELECTION

White

CARPET COLOR SELECTIONS

Grey Red Teal Blue Black Burgundy Purple

HEADER TO READ (up to 20 characters, black lettering on white)

Header One

Header Two

ACCESSORY OPTIONS

Description	Qty.	Discount Rate	Standard Rate	Total
1 meter Angled Shelves		80.00	104.00	
1 meter Shelves		70.00	91.00	
Spot Lights (For use with rental unit)		90.00	117.00	
Literature Pockets 8 1/2" x 11"		40.00	52.00	
Nylon Loop Fabric Panel per sq.ft. <small>**contact for available color options</small>		\$5.25 sq.ft.	\$6.83 sq.ft.	

SPECIAL INSTRUCTIONS

EXHIBITOR INFORMATION

COMPANY

CONTACT

BOOTH#

COST SUMMARY

RATE ADJUSTMENT	(OFFICE USE ONLY)	
25% CANCELLATION FEE	(OFFICE USE ONLY)	
SUBTOTAL		
2.0% CREDIT CARD FEE		
7.0% SALES TAX		
TOTAL	US DOLLARS	

PLEASE REFER TO THE PAYMENT & CREDIT CARD CHARGE AUTHORIZATION FORM

ORDERS WILL NOT BE PROCESSED WITHOUT PAYMENT

STANDARD RATE will be applied to all orders not received and paid in full by **June 22, 2026**. We reserve the right to adjust orders calculated incorrectly.

A 25% CANCELLATION FEE will be applied to all orders received and then cancelled 2 weeks prior to install. If full service has been provided then 100% of original fee will be applied.
 xpo21_rentalexhibits

CUSTOM EXHIBITS

A more sophisticated technique to exhibit marketing messages creatively and effectively!

With decades of service, Levy continues to provide viable and reliable alternatives to maximize clients' overall booth space. Our sales team and design specialists work closely with each and every client to create a unique exhibit designed to meet a wide variety of today's marketing strategies. Whether the image and budget are conservative or extravagant Levy exceeds to offer the most suitable and perfect space solutions.



Collaboratively designed to meet your specific requirements, budget, and bring your vision to reality.

Each Levy Custom Designed Exhibit will be built to exact specifications and will be:

- Unique
- Attractive
- Versatile
- Impressive
- Memorable
- Functional
- Creative
- Inviting
- Efficient

Let us help you create a one of a kind booth space.

Call our experienced professionals for an innovative, customized, and no obligation approach.

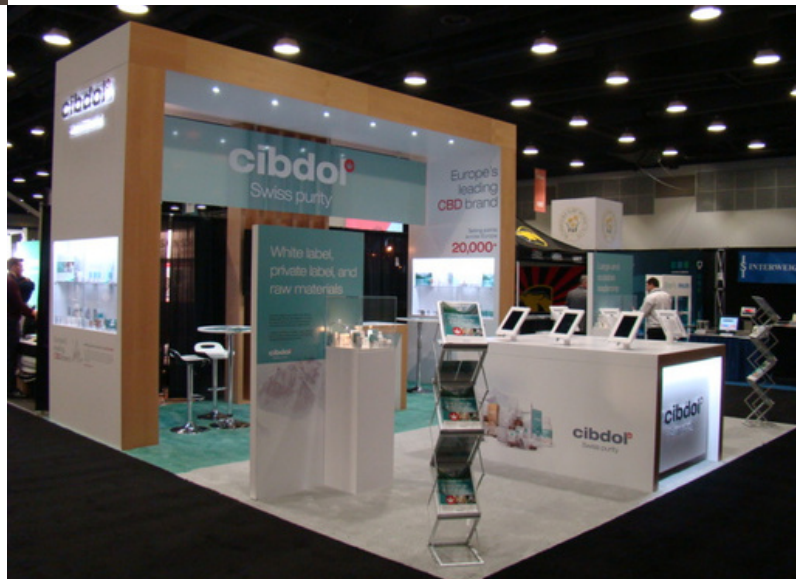

CABINETS

Straight Cabinets

All straight cabinets come with sliding doors. Optional Upgrades noted below:

- Lock for doors
- Lighting
*Jewelry Case or Show Case
- Branding - graphic panels



Cabinet "A"

1 meter cabinet with doors
39" long x 20" deep x 40" high



Cabinet "B"

1 meter Jewelry Case with doors
39" long x 20" deep x 40" high



Cabinet "C"

1 meter Show Case with doors
39" long x 20" deep x 40" high



Cabinet "D"

2 meter cabinet with doors
80" long x 20" deep x 40" high

Curved Cabinets

Optional Upgrades noted below:

- Lock for doors
- Branding - graphic panels



Cabinet "E"

1 meter curved cabinet
61" long x 20" deep x 40" high

Cabinet "F"

1 meter curved cabinet with door
61" long x 20" deep x 40" high

**Same as cabinet "E" but with door

**DISCLAIMER* Actual products and colors available may vary from the images shown. All products subject to availability*

Do you have questions?

We would be pleased to help. Contact us at: 253 437 0031

operations@levyexpo.com

www.levyexpo.com

CABINETS ORDER FORM & INVOICE

STYLE	DESCRIPTION	QTY	DISCOUNT RATE	STANDARD RATE	TOTAL
CABINET "A"	1 meter Cabinet with doors <input type="checkbox"/> Lock (\$20.00 each)		760.00	988.00	
	Cabinet with + custom graphic panel <input type="checkbox"/> Lock (\$20.00 each)		935.00	1,216.00	
CABINET "B"	1 meter Jewelry Case with doors <input type="checkbox"/> Lock (\$20.00 each) <input type="checkbox"/> Lights (\$20.00 each)		910.00	1,183.00	
	Jewelry Case + custom graphic panel <input type="checkbox"/> Lock (\$20.00 each) <input type="checkbox"/> Lights (\$20.00 each)		1,035.00	1,346.00	
CABINET "C"	1 meter Show Case with doors <input type="checkbox"/> Lock (\$20.00 each) <input type="checkbox"/> Lights (\$20.00 each)		990.00	1,287.00	
	Show Case + custom graphic panel <input type="checkbox"/> Lock (\$20.00 each) <input type="checkbox"/> Lights (\$20.00 each)		1,080.00	1,404.00	
CABINET "D"	2 meter Cabinet with doors <input type="checkbox"/> Lock (\$20.00 each)		980.00	1,274.00	
	2 meter Cabinet + custom graphic panel <input type="checkbox"/> Lock (\$20.00 each)		1,350.00	1,755.00	
CABINET "E"	1 meter Curved cabinet (open back)		890.00	1,154.00	
	Curved cabinet + custom graphic panel		1,215.00	1,580.00	
CABINET "F"	1 meter Curved cabinet with doors <input type="checkbox"/> Lock (\$20.00 each)		965.00	1,255.00	
	Curved cabinet w/ doors + custom graphic panel		1,310.00	1,703.00	

NOTE: Should you wish to have a graphic panel upgrade for your cabinet, please contact our Operations department to confirm details on graphic file submission.

EXHIBITOR INFORMATION

COMPANY	
CONTACT	BOOTH#

COST SUMMARY

RATE ADJUSTMENT	(OFFICE USE ONLY)	
CANCELLATION FEE	(OFFICE USE ONLY)	
SUBTOTAL		
2.0% CREDIT CARD FEE		
7.0% SALES TAX		
TOTAL	US DOLLARS	

PLEASE REFER TO THE PAYMENT & CREDIT CARD CHARGE AUTHORIZATION FORM

ORDERS WILL NOT BE PROCESSED WITHOUT PAYMENT

STANDARD RATE will be applied to all orders not received and paid in full by **June 22, 2026**. We reserve the right to adjust orders calculated incorrectly.

A 25% CANCELLATION FEE will be applied to all orders received and then cancelled. If full service has been provided then 100% of original fee will be applied.

GRAPHICS AND SIGN ORDER FORM & INVOICE

STANDARD SIGN SIZES

Quantity	Description	Discount Rate	Standard Rate	Total
	7" x 11"	32.00	41.25	
	7" x 44"	38.25	49.50	
	11" x 14"	48.50	62.75	
	14" x 22"	64.90	84.50	
	22" x 28"	81.50	106.25	
	28" x 44"	116.50	151.50	

Prices listed are for one-color copy (up to 10 words) on a white background.

OPTIONAL SERVICES

Quantity	Description	Discount Rate	Standard Rate	Total
	Over 10 words (Add per word)	3.75	4.85	
	Easel back on sign (Up to 22" x 28")	5.00	6.45	
	Logo sign	Quoted on Request		
	Banner	Quoted on Request		

DIGITAL GRAPHICS (6 SQ FT MINIMUM)

- Digital files must be provided to LES specifications.
- Graphics should be sent in vector format as .eps files.
 Also acceptable: Adobe Illustrator (.ai) & Corel Draw (.cdr) files
- Photographic & Pixel based complex graphics must be MINIMUM 100 dpi at actual output size.
 Acceptable formats include: .tif, .bmp, & Adobe Photoshop & Corel Photo Paint files
- All text **MUST** be outlined / converted to curves, or fonts included with image files.
- Art work is to be received as file ready.
- Editing & Design time is charged at a rate of \$75.00 per hour (1 hour minimum).
- Digital files must be received at least three (3) weeks before show to receive discount price.

Quantity	Description	Discount Rate	Standard Rate	Total
	Digital Prints per sq.ft. (Mounted on Foamcore w/ Matte Laminates)	\$20.10	\$29.90	

EXHIBITOR INFORMATION

COMPANY

CONTACT

BOOTH#

INDICATE YOUR SIGN COPY HERE

ADDITIONAL SERVICES & TERMS

If you would like us to provide more information and pricing on banners, logos, silk screening, special graphics or any other items please contact our Exhibits department for a complimentary consultation.

Orders required within 72 hours before show opening may be subject to a rush delivery charge. Please allow a minimum of 24 hours for any on-site sign orders.

CHOOSE YOUR LAYOUT

Vertical
 Horizontal

Levy Exposition Services Inc.
to design layout

LETTER COLOR SELECTIONS

Blue
 Red
 Green
 Teal
 Black
 Purple

Black lettering will be provided unless otherwise specified.

SPECIAL INSTRUCTIONS

COST SUMMARY

RATE ADJUSTMENT	(OFFICE USE ONLY)	
100% CANCELLATION FEE	(OFFICE USE ONLY)	
SUBTOTAL		
2.0% CREDIT CARD FEE		
7.0% SALES TAX		
TOTAL	US DOLLARS	

PLEASE REFER TO THE PAYMENT & CREDIT CARD CHARGE AUTHORIZATION FORM

****ORDERS WILL NOT BE PROCESSED WITHOUT PAYMENT****

STANDARD RATE will be applied to all orders not received and paid in full by **June 22, 2026**. We reserve the right to adjust orders calculated incorrectly.

A 100% CANCELLATION FEE will be applied to all orders received then cancelled.

PLANT & FLOWER RENTAL ORDER FORM & INVOICE

LIVE PLANTS

Quantity	Description	Discount Rate	Standard Rate	Total
	Potted flowers	72.00	93.60	
	Boston fern	84.00	109.20	
	Hanging green plant	84.00	109.20	

LIVE TROPICAL PLANTS

Quantity	Description	Discount Rate	Standard Rate	Total
	3' - 4' tall floor plant	108.00	140.40	
	4' - 5' tall floor plant	136.00	176.80	
	6' tall floor plant	154.00	200.20	

COLORFUL FRESH CUT FLOWERS

Quantity	Description	Discount Rate	Standard Rate	Total
	Small floral arrangement	225.00	292.50	
	Large floral arrangement	260.00	338.00	

Please indicate color preference here, if any: _____

The above items are priced on a rental basis only. Prices above include container, installation and removal at the end of show.
All orders will be subject to a \$25.00 delivery fee.
 Any items missing from the booth upon dismantling are the responsibility of the exhibitor and an additional charge will be applied.

SPECIAL INSTRUCTIONS

EXHIBITOR INFORMATION

COMPANY _____

CONTACT _____

BOOTH# _____

COST SUMMARY

RATE ADJUSTMENT	(OFFICE USE ONLY)	
25% CANCELLATION FEE	(OFFICE USE ONLY)	
SUBTOTAL		
\$25.00 DELIVERY FEE		
2.0% CREDIT CARD FEE		
7.0% SALES TAX		
TOTAL	US DOLLARS	

PLEASE REFER TO THE PAYMENT & CREDIT CARD CHARGE AUTHORIZATION FORM

ORDERS WILL NOT BE PROCESSED WITHOUT PAYMENT

STANDARD RATE will be applied to all orders not received and paid in full by **June 22, 2026**. We reserve the right to adjust orders calculated incorrectly.

A 25% CANCELLATION FEE will be applied to all orders received then canceled. If full service has been provided then 100% of original fee will be applied.



Fax: 253 437 0032
 14900 Interurban Avenue South, Suite 271
 Seattle, WA
 USA 98168
 Telephone: 253 437 0031
 E-mail: operations@levyexpo.com

APSCON / APSCON UNMANNED 2026
July 13 - 17, 2026
Broward County Convention Center
Fort Lauderdale, FL

IN-BOOTH FORKLIFT ORDER FORM & INVOICE

TERMS & CONDITIONS

The exhibitor, his agent or representative must supply sufficient manpower including competent and authorized supervisors to manage and control the exhibit installation activity.

The exhibitor, upon signing this order form, covenants and agrees to indemnify and hold harmless Levy Exposition Services Inc., from and against all claims, demands, charges, losses or damage arising or alleged to arise directly or indirectly or incidentally by person of any act omission or operations of the exhibitor, his agent or representative, their officers, employees, agents or anyone for whom the exhibitor, his agent or representative are legally responsible. Levy Exposition Services Inc., is to be cross insured on the insurance for the exhibitor's, his agent's or representative's operations conducted at this event. Evidence of the insurance described above shall be forwarded to Levy Exposition Services Inc.

THIS SERVICE IS NOT PROVIDED BY SHOW MANAGEMENT

RATES

DESCRIPTION	STANDARD RATE	
STRAIGHT TIME 8:00 AM - 4:30 PM Monday to Friday (Includes 5000 lb. Forklift and operator)	\$310.00 per Hour	
STRAIGHT TIME 8:00 AM - 4:30 PM Monday to Friday (Foreman)	\$144.25 per Hour	
OVERTIME 4:30 PM - 8:00 AM Monday to Friday, (Includes 5000 lb Forklift and operator) All day Saturday, Sunday, and holidays	\$391.50 per Hour	
OVERTIME 4:30 PM - 8:00 AM Monday to Friday, (Foreman) All day Saturday, Sunday, and holidays	\$262.00 per Hour	

ESTIMATED INSTALLATION REQUIREMENTS

DESCRIPTION	STANDARD RATE	TOTAL	There is a minimum charge of one (1) hour per forklift. Additional time thereafter is charged in one-half (½) hour increments. Date Required _____ Start Time _____
STRAIGHT TIME _____ Forklift _____ Hours	\$310.00 per Hour	\$_____ Total	
OVERTIME _____ Forklift _____ Hours	\$391.50 per Hour	\$_____ Total	

ESTIMATED DISMANTLE REQUIREMENTS

DESCRIPTION	STANDARD RATE	TOTAL	There is a minimum charge of one (1) hour per forklift. Additional time thereafter is charged in one-half (½) hour increments. Date Required _____ Start Time _____
STRAIGHT TIME _____ Forklift _____ Hours	\$310.00 per Hour	\$_____ Total	
OVERTIME _____ Forklift _____ Hours	\$391.50 per Hour	\$_____ Total	

EXHIBITOR INFORMATION

COMPANY _____

CONTACT _____ **BOOTH#** _____

***PLEASE ADD 25% FOR ORDERS PLACED AFTER JUNE 22, 2026.**

COST SUMMARY

RATE ADJUSTMENT	(OFFICE USE ONLY)	
25% CANCELLATION FEE	(OFFICE USE ONLY)	
SUBTOTAL		
2.0% CREDIT CARD FEE		
ADDITIONAL 25% LATE ORDER		
TOTAL	US DOLLARS	

PLEASE REFER TO THE PAYMENT & CREDIT CARD CHARGE AUTHORIZATION FORM

ORDERS WILL NOT BE PROCESSED WITHOUT PAYMENT

A 25% CANCELLATION FEE will be applied to all orders received then canceled. Orders cancelled within 7 days of scheduled start date will be charged 100% of the original fee.



Fax: 253 437 0032
 14900 Interurban Avenue South, Suite 271
 Seattle, WA
 USA 98168
 Telephone: 253 437 0031
 E-mail: operations@levyexpo.com

APSCON / APSCON UNMANNED 2026
 July 13 - 17, 2026
 Broward County Convention Center
 Fort Lauderdale, FL

SIGN & BANNER HANGING ORDER FORM & INVOICE

TERMS AND CONDITIONS

ALL OVERHEAD HANGING SIGNS MUST BE ASSEMBLED, INSTALLED AND DISMANTLED BY LEVY. SIGN ASSEMBLY REQUIRES A 2 PERSON CREW. THE REQUIRED AMOUNT OF MAN HOURS TO ASSEMBLE YOUR SIGN(S) WILL BE ADDED TO YOUR ACCOUNT UPON COMPLETION OF THE WORK. THERE IS A MINIMUM CHARGE OF 1 HOUR FOR INSTALL AND 1 HOUR FOR DISMANTLE FOR ALL SIGN HANGING SERVICES.
****THE SIGN ASSEMBLY LABOR ORDER FORM FOLLOWING THIS FORM MUST BE COMPLETED AND SUBMITTED WITH SIGN ASSEMBLY INSTRUCTIONS****

This order form is for labor and equipment that may be required for the hanging of signs, banners, decorations, etc. This order will be considered as a tentative reservation and **must be confirmed with a signed work order** at the Levy Exposition Services Inc. service desk.
 A sign hanging crew consists of two men and a boom lift.

SIGN & BANNER HANGING LABOR RATES

REGULAR TIME	8:00 AM - 4:30 PM Monday to Friday	Boom lift + two person crew - \$968.25 per Hour / minimum 1 hour Additional Rigger(s) - \$144.25 per Person per Hour / minimum 1 hour
OVER TIME	4:30 PM - 8:00 AM Monday to Friday, All day Saturday, Sunday and Holidays	Boom lift + two person crew - \$1,168.25 per Hour / minimum 1 hour Additional Rigger(s) - \$262.00 per Person per Hour / minimum 1 hour

ESTIMATED SIGN HANGING INSTALLATION REQUIREMENTS

REGULAR TIME	Laborers	Date Required	Start Time	Approx. Hours	Boom lift + two person crew - \$968.25 per Hour Additional Rigger(s) - \$144.25 per Person per Hour	\$ _____ Total
OVER TIME	Laborers	Date Required	Start Time	Approx. Hours	Boom lift + two person crew - \$1,168.25 per Hour Additional Rigger(s) - \$262.00 per Person per Hour	\$ _____ Total

ESTIMATED SIGN HANGING DISMANTLE REQUIREMENTS

REGULAR TIME	Laborers	Date Required	Start Time	Approx. Hours	Boom lift + two person crew - \$968.25 per Hour Additional Rigger(s) - \$144.25 per Person per Hour	\$ _____ Total
OVER TIME	Laborers	Date Required	Start Time	Approx. Hours	Boom lift + two person crew - \$1,168.25 per Hour Additional Rigger(s) - \$262.00 per Person per Hour	\$ _____ Total

NOTE: Any miscellaneous rigging supplies such as cable, shackles etc. required to install your sign will be calculated and added to your invoice upon completion of the installation

****PLEASE ADD 25% TO ORDERS PLACED AFTER JUNE 22, 2026****

All Rates are based on current wage scales and are subject to change in accordance with existing wage scales at the time of the exposition

SPECIAL INSTRUCTIONS

EXHIBITOR INFORMATION

COMPANY _____

CONTACT _____ **BOOTH#** _____

SUPERVISION SERVICES

- (PLEASE INDICATE DESIRED SERVICE)
- EXHIBITOR SUPERVISED
- LEVY SUPERVISED (PLEASE ADD 50% FOR THIS SERVICE)

COST SUMMARY

RATE ADJUSTMENT	(OFFICE USE ONLY)	
25% CANCELLATION FEE	(OFFICE USE ONLY)	
SUBTOTAL		
SUPERVISION 50%		
ADDITIONAL 25% LATE ORDER		
2.0% CREDIT CARD FEE		
TOTAL	US DOLLARS	

PLEASE REFER TO THE PAYMENT & CREDIT CARD CHARGE AUTHORIZATION FORM
****ORDERS WILL NOT BE PROCESSED WITHOUT PAYMENT****

A 25% CANCELLATION FEE will be applied to all orders received then canceled. Orders cancelled within 7 days of scheduled start date will be charged 100% of the original fee.



Fax: 253 437 0032
 14900 Interurban Avenue South, Suite 271
 Seattle, WA
 USA 98168
 Telephone: 253 437 0031
 E-mail: operations@levyexpo.com

APSCON / APSCON UNMANNED 2026
July 13 - 17, 2026
 Broward County Convention Center
 Fort Lauderdale, FL

SIGN ASSEMBLY LABOR ORDER FORM & INVOICE

TERMS & CONDITIONS

SIGN ASSEMBLY REQUIRES A 2 PERSON CREW. THE REQUIRED AMOUNT OF MAN HOURS TO ASSEMBLE YOUR SIGN(S) WILL BE ADDED TO YOUR ACCOUNT UPON COMPLETION OF THE WORK.

PLEASE NOTE: It is required to include sign assembly instructions when submitting your order.

****THIS SERVICE IS FOR SIGN ASSEMBLY ONLY. FOR GENERAL LABOR, PLEASE REFER TO THE LABOR ORDER FORM****

SIGN ASSEMBLY LABOR RATES

REGULAR TIME	8:00 AM - 4:30 PM Monday to Friday	\$144.25 per Person per Hour / minimum 2 hours
OVER TIME	Before 8:00 am and after 4:30 pm Monday to Friday, All day Saturday, Sunday, and holidays.	\$262.00 per Person per Hour / minimum 2 hours

****two person crew is required for sign assembly labor****

ESTIMATED INSTALLATION REQUIREMENTS

REGULAR TIME	___ Laborers	___ Hours	\$144.25 per Person per Hour	\$ _____ Total	A minimum charge for labor is two (2) hours. One (1) hour per two person crew. Labor thereafter is charged in one-half (1/2) hour increments. Date Required _____ Start Time _____
OVER TIME	___ Laborers	___ Hours	\$262.00 per Person per Hour	\$ _____ Total	

ESTIMATED DISMANTLE REQUIREMENTS

REGULAR TIME	___ Laborers	___ Hours	\$144.25 per Person per Hour	\$ _____ Total	A minimum charge for labor is two (2) hours. One (1) hour per two person crew. Labor thereafter is charged in one-half (1/2) hour increments. Date Required _____ Start Time _____
OVER TIME	___ Laborers	___ Hours	\$262.00 per Person per Hour	\$ _____ Total	

SUPERVISION SERVICES

(PLEASE INDICATE DESIRED SERVICE)

- EXHIBITOR SUPERVISED
- LEVY SUPERVISED (PLEASE ADD 50% FOR THIS SERVICE)

****PLEASE ADD 25% TO ORDERS PLACED AFTER JUNE 22, 2026****

EXHIBITOR INFORMATION

COMPANY _____

CONTACT _____ **BOOTH#**

COST SUMMARY

RATE ADJUSTMENT	(OFFICE USE ONLY)	
CANCELLATION FEE	(OFFICE USE ONLY)	
SUBTOTAL		
SUPERVISION 50%		
ADDITIONAL 25% LATE ORDER		
2.0% CREDIT CARD FEE		
TOTAL US DOLLARS		

PLEASE REFER TO THE PAYMENT & CREDIT CARD CHARGE AUTHORIZATION FORM

****ORDERS WILL NOT BE PROCESSED WITHOUT PAYMENT****

TERMS & CONDITIONS Gratuities in any form, including cash, gifts or labor hours for work not actually performed are prohibited. We reserve the right to adjust orders calculated incorrectly.

A 25% CANCELLATION FEE will be applied to all orders received then canceled. Orders cancelled within 7 days of scheduled start date will be charged 100% of the original fee.



Fax: 253 437 0032
 14900 Interurban Avenue South, Suite 271
 Seattle, WA
 USA 98168
 Telephone: 253 437 0031
 E-mail: operations@levyexpo.com

APSCON / APSCON UNMANNED 2026
July 13 - 17, 2026
 Broward County Convention Center
 Fort Lauderdale, FL

LABOR ORDER FORM & INVOICE

SUPERVISION SERVICES (Please indicate desired service)

LEVY EXPOSITION SERVICES INC. SUPERVISED

MOVE IN MOVE OUT

LEVY EXPOSITION SERVICES INC. WILL SUPERVISE labor to unpack and install display before exhibitor arrival at show site and/or dismantle and pack display after show closing.

A **50% Surcharge** will be added to the labor rates below for this professional supervision.

EXHIBITOR SUPERVISED

MOVE IN MOVE OUT

EXHIBITOR WILL SUPERVISE the laborers provided by Levy Exposition Services Inc. for the installation and/or dismantle of the exhibit.

Supervisor's name _____

Starting time can be guaranteed only when labor is requested for the start of the working day at 8 AM or 30 minutes after the start of move out. For all other starting times, check in at the **Exhibitor Service Desk** one-half (1/2) hour before time requested.

LABOR RATES

REGULAR TIME	8:00 AM - 4:30 PM Monday to Friday	\$144.25 per Hour
OVER TIME	Before 8:00 am and after 4:30 pm Monday to Friday, All day Saturday, Sunday, and holidays.	\$262.00 per Hour

ESTIMATED INSTALLATION REQUIREMENTS

REGULAR TIME	____ Laborers	____ Hours	\$144.25 per Hour	\$ _____ Total	A minimum charge for labor is one (1) hour per laborer. Labor thereafter is charged in one-half (1/2) hour increments. Date Required _____ Start Time _____
OVER TIME	____ Laborers	____ Hours	\$262.00 per Hour	\$ _____ Total	

ESTIMATED DISMANTLE REQUIREMENTS

REGULAR TIME	____ Laborers	____ Hours	\$144.25 per Hour	\$ _____ Total	A minimum charge for labor is one (1) hour per laborer. Labor thereafter is charged in one-half (1/2) hour increments. Date Required _____ Start Time _____
OVER TIME	____ Laborers	____ Hours	\$262.00 per Hour	\$ _____ Total	

INBOUND FREIGHT INFORMATION ****BE SURE TO COMPLETE THE OUTBOUND FORM AS WELL****

Carrier	Date Shipped	Pro Number
Number of Pieces	Weight	Arrival Date (Target)
<input type="checkbox"/> Loose Display <input type="checkbox"/> Crated Display		
Quantity of Ladders Required (Optional)		

EXHIBITOR INFORMATION

COMPANY	
CONTACT	BOOTH#

PLEASE ADD 25% FOR ORDERS PLACED AFTER JUNE 22, 2026

COST SUMMARY

RATE ADJUSTMENT	(OFFICE USE ONLY)	
CANCELLATION FEE	(OFFICE USE ONLY)	
SUBTOTAL		
2.0% CREDIT CARD FEE		
SUPERVISION 50%		
ADDITIONAL 25% LATE ORDER		
TOTAL	US DOLLARS	

PLEASE REFER TO THE PAYMENT & CREDIT CARD CHARGE AUTHORIZATION FORM
****ORDERS WILL NOT BE PROCESSED WITHOUT PAYMENT****

TERMS & CONDITIONS Gratuities in any form, including cash, gifts or labor hours for work not actually performed are prohibited. We reserve the right to adjust orders calculated incorrectly.

A 25% CANCELLATION FEE will be applied to all orders received then canceled. Orders cancelled within 7 days of scheduled start date will be charged 100% of the original fee.
 xpo21_labor

OUTBOUND SHIPPING INSTRUCTIONS - DISMANTLE LABOR

Exhibitor Name:	Tel. #:	Booth #
Billing Address:	Fax #:	
City / State / Zip:	Auth. by:	

1 Outbound Shipping Instructions

Please complete this section if Levy will be supervising dismantle booth labor:

Exhibitor Outbound Shipping Instructions: At close of the show, exhibitor freight will be shipped to the address provided below.

If your freight is being forwarded to another show, be sure to include the name of show and your booth number

Company / Show: _____ **Booth #:** _____

Address: _____

City / State / Zip: _____

Attention: _____

Select Carrier

Ship via carrier of exhibitor's choice

Name of Carrier: _____

Ship via official show freight carrier

Select shipping method Ground

Air **Select Service Provider:** _____

Please note:

■ The exhibitor is responsible for arranging either a carrier of their choice or the official show freight carrier to pick up at the close of the show.

■ Levy cannot guarantee pick up time for exhibitor appointed carriers. All shipments are moved out of the exhibit hall at Levy's discretion.

Please review the Quick Facts for the Carrier Check-in time

2 Billing Information

Please indicate billing information for carrier charges if different than above.

Bill Shipping Charges to (if different from above):

Shipper (signature): _____ **Shipper (print name):** _____

Freight Charges Billed To (Company/Show): _____

Address: _____

City / State / Zip: _____

Telephone: _____ **Attention:** _____

PAYMENT & LABOR

The terms and conditions set forth below become part of the contractual agreement between Levy Exposition Services Inc. and you, the EXHIBITOR. Acceptance of said terms and conditions will be construed when any of the following conditions are met:

- ~ **WHEN THE METHOD OF PAYMENT FORM IS SIGNED; OR**
- ~ **WHEN AN ORDER FOR LABOR, SERVICES, AND/OR RENTAL EQUIPMENT IS PLACED BY AN EXHIBITOR WITH LEVY EXPOSITION SERVICES INC.; OR**
- ~ **WHEN WORK IS PERFORMED ON BEHALF OF EXHIBITOR BY LABOR SECURED THROUGH LEVY EXPOSITION SERVICES INC.**

DEFINITIONS

“Levy Exposition Services Inc.” (“LES”), and any sub-contractors affiliated within the show. The term EXHIBITOR shall be construed within the meaning of this contract as the EXHIBITOR and/or its employees, agents, representatives, and/or any Exhibitor Appointed Contractor (E.A.C.).

PAYMENT TERMS

Full payment, including any applicable tax, is due in advance or at show site. All payments must be in U.S. Funds and all checks must be drawn on a U.S. Bank. Orders received without advance payment or after the deadline date will incur additional [After Deadline] charges as indicated on each order form. All materials and equipment are on a rental basis for the duration of the show or event and remain the property of LES except where specifically identified as a sale. All LES rentals include delivery, installation and removal from EXHIBITOR's booth, unless stated otherwise. In case of cancellation, a one-hour “per person, per hour” charge will be applied to all labor, forklift and sign hanging orders that are not canceled in writing at least seven (7) days prior to the scheduled start time. If services have already been provided at the time of cancellation, 100% of original fee will be applied. It is EXHIBITOR'S responsibility to advise LES Exhibitor Services personnel of any problem with any order, and to check invoices for accuracy prior to the close of the exhibit. If EXHIBITOR is exempt from payment of sales tax, LES requires an exemption certificate for the State in which the services are to be used. Resale certificates are not valid unless EXHIBITOR is rebilling these charges to its customers. For International EXHIBITORS, LES requires 100% prepayment of advance orders, and any orders or services placed at show site must be paid at the show. For all others, should there be any pre-approved unpaid balance after the close of the show, terms will be net, due and payable in the UNITED STATES OF AMERICA, upon receipt of invoice. Effective 30 days after invoice date, any unpaid balance will bear a FINANCE CHARGE at the lesser of the maximum rate allowed by applicable law, or 1.5% per month, which is an ANNUAL PERCENTAGE RATE of 18%, and future orders will be on a pre-paid basis only. If any finance charge here under exceeds the maximum rate allowed by applicable law, the finance charge shall automatically be reduced to the maximum rate allowed, and any excess finance charge received by LES shall either be applied to reduce the principal unpaid balance or refunded to the payer. These payment terms and conditions shall be governed by and construed in accordance with the LAWS OF THE STATE OF FLORIDA. In the event of any dispute between EXHIBITOR and LES relative to any loss, damage, or claim, such EXHIBITOR shall not be entitled to and shall not withhold payment, or any partial payment, due to LES relative to any services, as an offset against the amount of any alleged loss or damage. Any claim against LES shall be considered a separate transaction, and shall be resolved on its own merits. LES reserves the right to charge EXHIBITOR for the difference between the EXHIBITOR's estimate of charges and the actual charges incurred by the EXHIBITOR, or for any charges that LES may be obligated to pay on behalf of the EXHIBITOR, including without limitation, any shipping charges.

LABOR PROVIDED UNDER THE SUPERVISION OF LES

RESPONSIBILITIES

LES shall be responsible for the performance of labor provided under this option. LES cannot assume responsibility for any acts of, or loss to, persons, parties and/or other contracting firms not under LES's direct supervision and control. In no event shall LES be liable for loss or damage caused by delay in labor beginning work when EXHIBITOR requests labor to begin later than the start of the working day. LES shall not be responsible for loss, delay or damage due to strike, lockouts, and/or work stoppages, or other causes beyond LES's reasonable control.

INDEMNIFICATION

LES agrees to indemnify, hold harmless, and defend EXHIBITOR from and against any and all demands, claims, causes of action, fines, penalties, damages, liabilities, judgments, and expenses (including but not limited to reasonable attorneys' fees and investigation costs) for bodily injury, including any injury to LES employees, or property damage arising out of work performed by labor provided by and supervised by LES, except when EXHIBITOR exercises direction and/or control over the work being performed.

LABOR PROVIDED UNDER THE SUPERVISION OF EXHIBITOR

RESPONSIBILITIES

EXHIBITOR shall be responsible for the performance of labor provided under this section. It is responsibility of EXHIBITOR to supervise labor secured through LES in a reasonable manner as to prevent bodily injury and/or property damage and also to direct them to work in a manner that is in compliance with LES Safe Work Rules and/or Federal, State, County and Local ordinances, rules and/or regulations, including but not limited to Show or Facility Management Rules and/or Regulations. It is the responsibility of EXHIBITOR to check in with the Service Desk to pick up labor, and to return to the Service Desk to release labor when the work is completed.

INDEMNIFICATION

EXHIBITOR agrees to indemnify, hold harmless, and defend LES from and against any and all demands, claims, causes of action, fines, penalties, damages, liabilities, judgements, and expenses (including but not limited to reasonable attorneys' fees and investigation costs) for bodily injury, including any injury to LES employees, and/or property damage arising out of work performed by labor provided by LES but supervised by EXHIBITOR. Further, EXHIBITOR's indemnification of LES includes any and all violations of Federal, State, County or Local ordinances, “Show Regulations and/or Rules” as published and/or set forth by Facility or Show Management, and/or directing labor provided by LES to work in a manner that violates any of the above rules, regulations, and/or ordinances.

IMPORTANT

PLEASE REFER TO LES's MATERIAL HANDLING TERMS AND CONDITIONS AS THEY RELATE TO MATERIAL HANDLING SERVICES. CONTRACTUAL TERMS DEPEND ON THE NATURE OF SERVICES SECURED BY EXHIBITOR THROUGH LES. TERMS & CONDITIONS MAY VARY FOR EACH TYPE OF SERVICE ORDERED THROUGH LES.

TERMS & CONDITIONS





MOTORIZED VEHICLE ESCORT ORDER FORM

Submit this form if you wish to display a vehicle at show site. This form must be received by Levy Exposition Service prior to vehicles being received. Enter the total below to the Payment & Credit Card Charge Authorization Form. Orders received without full payment or credit card information will not be processed.

FIRE REGULATIONS

Vehicle may only be displayed in accordance with local fire regulations and prior approval of Show Management

DELIVERY DETAILS

Date: _____ Time: _____

RATE

Vehicle: _____ x \$375.00 round trip = \$_____ (subtotal)

Information

- Any vehicle brought into the exhibit hall will be escorted from the landing ramp to the booth.
- Escort fees are \$375.00 round trip.
- Display materials transported in display vehicles are subject to material handling charges.
- Weights will be estimated by Levy Exposition Service unless documentation is provided.

TERMS / ORDER ESTIMATE

- Vehicles must have ¼ tank of gas or less
- Once positioned in the display area, the battery must be disconnected
- Gas caps must be locked or taped closed
- Orders cancelled prior to move-in will be charged 50% of the original price.
- Orders cancelled after move-in begins will be charged 100% of the original price.
- Transfer this total to the Payment & Credit Card Charge Authorization Form.

Total Estimate: _____

Exhibiting Company: _____ Booth # _____



AIRCRAFT ESCORT ORDER FORM

Submit this form if you wish to display a vehicle at show site. This form must be received by Levy Exposition Service prior to vehicles being received. Enter the total below to the Payment & Credit Card Charge Authorization Form. Orders received without full payment or credit card information will not be processed.

FIRE REGULATIONS

Aircraft may only be displayed in accordance with local fire regulations and prior approval of Show Management

DELIVERY DETAILS

Date: _____ Time: _____

RATE

Aircraft: _____ x \$490.00 each way = \$_____ (subtotal)

Information

- Any aircraft brought into the exhibit hall will be escorted from the landing area to the booth.
- Escort fees are \$490.00 each way.
- Display materials transported in display vehicles are subject to material handling charges.
- Weights will be estimated by Levy Exposition Service unless documentation is provided.

TERMS / ORDER ESTIMATE

- Orders cancelled prior to move-in will be charged 50% of the original price.
- Orders cancelled after move-in begins will be charged 100% of the original price.
- Transfer this total to the Payment & Credit Card Charge Authorization Form.

Total Estimate: _____

Exhibiting Company: _____ Booth # _____

SOLO RATE

ONE RATE. ONE FEE.

LEVY
EXPOSITION SERVICES INC.



THE SIMPLIFIED PRICING OF PAYING PER POUND INCLUDES:

- Receiving and unloading your materials at the advance warehouse.
- Secure storage of materials for up to 30 days before the show.
- Transfer to show-site, unload, and deliver materials to your booth.
- Removal and storage of empty containers during the show.
- Returning empties from storage at the close of the show.
- Outbound loading of your materials onto your carrier of choice or Levy's official carrier.



MATERIAL HANDLING FAQs

The following is a list of frequently asked questions pertaining to material handling and freight services. We strongly recommend that you read this document in its entirety to better familiarize yourself with the processes relating to material handling and freight services.

As the official service contractor, LEVY is the exclusive provider of freight services. Material handling includes unloading your exhibit material, storing up to 30 days in advance at the warehouse address, delivering to the booth, the handling of empty containers to and from storage, and removing of material from the booth for reloading onto outbound carriers. It should not be confused with the cost to transport your exhibit material to and from the convention or event. You have two options for shipping your advance freight — either to the warehouse or directly to show site.

HOW DO I SHIP TO THE ADVANCE WAREHOUSE?

- We will accept freight beginning 30 days prior to show move-in.
- To check on your freight arrival, call Exhibitor Services at the number listed on the Quick Facts.
- To ensure timely arrival of your materials at show site, freight should arrive by the deadline date listed on the Quick Facts and Shipping Instructions pages. Your freight will still be received after the deadline date, but additional charges will be incurred.
- The warehouse will receive shipments Monday through Friday, except holidays. Refer to the Shipping Instructions page for warehouse receiving hours.
- The warehouse will accept crates, cartons, skids, trunks/cases and carpets. Loose or pad-wrapped materials must be sent directly to show site.
- All shipments must have a bill of lading or delivery slip indicating the number of pieces, type of merchandise and weight.
- Certified weight tickets must accompany all shipments.
- Warehouse freight will be delivered to the booth prior to exhibitor setup.
- Please call the number located on the Quick Facts if you want to ship oversized material that requires special equipment to the warehouse.

HOW DO I SHIP TO SHOW SITE?

- Freight will be accepted only during exhibitor move-in. Please refer to the Quick Facts for the specific exhibitor move-in dates and times.
- All shipments must have a bill of lading or delivery slip indicating the number of pieces, type of merchandise and weight.
- Certified weight tickets must accompany all shipments.

WHAT ABOUT PREPAID OR COLLECT SHIPPING CHARGES?

- Collect shipments will be returned to the delivery carrier.
- To ensure that your freight does not arrive “collect,” mark your bill of lading “prepaid.”
- “Prepaid” designates that the transportation charges will be paid by the exhibitor or a third party.

HOW SHOULD I LABEL MY FREIGHT?

- The label should contain the exhibiting company name, the booth number and the name of the event.
- The specific shipping address for either the warehouse or show site can be found on the Quick Facts and Shipping Instructions pages.

HOW DO I ESTIMATE MY MATERIAL HANDLING CHARGES?

- Charges will be based on the weight of your shipment. Each shipment received is considered separately. The shipment weight will be multiplied by the applicable per pound rate with no round-ups. All shipments are subject to reweigh.
- On the Order Form, select whether the freight will arrive at the warehouse or be sent directly to show site.

Crated: material that is skidded or is in any type of shipping container that can be unloaded at the dock with no additional handling required.

- Add the late delivery charge listed on the Order Form if the shipment is accepted at the warehouse or at show site after the deadline date listed on the Quick Facts and Shipping Instructions pages.
- The above services, whether used completely or in part, are offered as a package and the charges will be based on the total inbound weight of the shipment.
- Shipments received without receipts or freight bills, such as UPS and Federal Express, will be delivered to the booth without guarantee of piece count or condition.

WHAT HAPPENS TO MY EMPTY CONTAINERS DURING THE SHOW?

- Pick up “Empty Labels” at the Service Center. Place a label on each container. Labeled containers will be picked up periodically and stored in non-accessible storage during the show.
- At the close of the show, the empty containers will be returned to the booth in random order. Depending on the size of the show, this process may take several hours.
- *Please note that LEVY will assume no liability for interrupted travel plans due to the length of time required for the empty container return. It is the responsibility of the exhibitor to schedule travel plans accordingly.*

HOW DO I PROTECT MY MATERIALS AFTER THEY ARE DELIVERED TO THE SHOW OR BEFORE THEY ARE PICKED UP AFTER THE SHOW?

- Consistent with trade show industry practices, there may be a lapse of time between the delivery of your shipment(s) to your booth and your arrival. The same is true for the outbound phase of the show — the time between your departure and the actual pick-up of your materials. During these times, your materials will be left unattended. We recommend that you arrange for a representative to stay with your materials or that you hire security services to safeguard your materials.

HOW DO I SHIP MY MATERIALS AFTER THE CLOSE OF THE SHOW?

- Each shipment must have a completed Material Handling Agreement in order to ship materials from the show. All pieces must be labeled individually.
- To save time, complete and submit the Outbound Shipping Form in advance, or you may contact the Service Center at show site for your shipping documents. The Material Handling Agreement and labels will be processed and available prior to show closing.
- After materials are packed, labeled, and ready to be shipped, the completed Material Handling Agreement must be turned in at the Service Center.
- Call your designated carrier with pick-up information. Please refer to the Quick Facts and Shipping Instructions pages for specific dates and times. In the event your selected carrier fails to show on final move-out day, your shipment will either be rerouted to LEVY’s carrier choice or delivered back to the warehouse at exhibitor’s expense.
- For your convenience, show-recommended carriers will be on site to handle outbound transportation.

WHERE DO I GET A FORKLIFT?

- Forklift orders to install or dismantle your booth after materials are delivered may be ordered in advance or at show site. We recommend that you order in advance to avoid additional charges at show site. Refer to the Order Form for available equipment.
- Advance and show-site orders for equipment and labor will be dispatched once a company representative signs the labor order at the Service Center.
- Start time is guaranteed only when equipment is requested for the start of the working day.

DO I NEED INSURANCE?

- Be sure your materials are insured from the time they leave your firm until they are returned after the show. It is suggested that exhibitors arrange all-risk coverage. This can be done by riders to your existing policies.
- All materials handled by LEVY are subject to the enclosed Terms and Conditions.

OTHER AVAILABLE SERVICES (may not be available in all locations)

- Cranes
- Scissor lifts, condors
- Access storage at show site
- Exhibit transportation services (see enclosed Liberty Convention Freight form)
- Security storage at show site
- Short-term and long-term warehouse storage
- Local pick-up and delivery



Fax: 253 437 0032
 14900 Interurban Avenue South, Suite 271
 Seattle, WA
 USA 98168
 Telephone: 253 437 0031
 E-mail: operations@levyexpo.com

APSCON / APSCON UNMANNED 2026
July 13 - 17, 2026
 Broward County Convention Center
 Fort Lauderdale, FL

SOLO RATE MATERIAL HANDLING ORDER FORM & INVOICE

SOLO RATE MATERIAL HANDLING SERVICES

DUE TO LIMITED MATERIAL HANDLING SERVICES AT THE BROWARD COUNTY CONVENTION CENTER, WE HIGHLY RECOMMEND THAT ALL MATERIALS BE SHIPPED TO OUR ADVANCE WAREHOUSE IN ORDER TO AVOID POTENTIAL DELAYS IN UNLOADING AT SHOW SITE.

Material Handling Service:

Levy Exposition Services Inc. is the exclusive provider of Solo Rate Material Handling Services for APSCON / APSCON UNMANNED 2026. Solo Rate Material Handling Services include:

- receiving and unloading your exhibit materials at the advance warehouse
- storage of exhibit materials for up to 30 days prior to the show
- transportation to show site, unloading and delivery of exhibit materials to your booth space,
- removal and storage of your empty containers during the event
- return of your empty containers at the close of the event
- outbound loading of your materials onto your carrier vehicle of choice at show site

You have the choice to ship to the advance warehouse prior to the show or to ship directly to the show site where your materials must arrive within the exhibitor move-in dates and times.

SOLO RATE MATERIAL HANDLING DESCRIPTIONS

Normal Warehouse Hours for Receiving Freight: 9:00 A.M. to 3:00 P.M. Monday through Friday, Holidays excluded.

Advance Receiving: Shipment(s) received at the Advance Warehouse *between June 8, 2026 and July 6, 2026.*

Early/Late to Warehouse & Off Target: Shipment(s) received at the Advance Warehouse *prior to June 8, 2026 or after July 6, 2026.* Shipments received at show site prior to, or after the posted exhibitor move-in day(s) / time(s).

Show Site Receiving: Shipment(s) shipped to and received at the **Broward County Convention Center.** Shipments cannot be received at the **Broward County Convention Center** prior to **8:00 am on Monday, July 13, 2026.**

Dedicated Delivery from Advance Warehouse: Any freight received at the Advance Warehouse after **July 6, 2026** could incur a \$650.00 delivery fee if a dedicated truck is required to deliver freight to show site.

Advance and Direct Shipment Rates	Price Per lb.
Advance Warehouse & Show Site Receiving Rate.....	\$3.30
Early/Late to Warehouse & Off Target Rate.....	\$3.95
Dedicated Delivery from Advance Warehouse (in addition to material handling rates).....	\$750.00 (flat fee)

PLEASE NOTE:

Acceptance of Terms & Conditions will be construed when the Material Handling Service Agreement is signed; or when exhibitor's materials are delivered to Levy Exposition Services Inc. warehouse or to a SHOW / EXPOSITION SITE for which Levy Exposition Services Inc. is the official show contractor.

Description	Weight in LBS	Price Per lb.	Estimated Total Charges
Advance Receiving - 1 crate, 2 boxes	298	\$3.30	\$983.40

EXHIBITOR INFORMATION

COMPANY _____

CONTACT _____ **BOOTH#** _____

RATE ADJUSTMENT (OFFICE USE ONLY)		
SUBTOTAL		
2.0% CREDIT CARD FEE		
TOTAL	US DOLLARS	

PLEASE REFER TO THE PAYMENT & CREDIT CARD CHARGE AUTHORIZATION FORM
 ORDERS WILL NOT BE PROCESSED WITHOUT PAYMENT

SHIPPING INSTRUCTIONS

SHIPMENTS CAN BE SENT DIRECTLY TO THE SHOW-SITE ON MOVE-IN DAY, OR TO THE ADVANCE WAREHOUSE UP TO THIRTY DAYS PRIOR TO MOVE-IN.

All freight shipped to the advance receiving warehouse must be properly crated, boxed, or stretch wrapped on pallets.

ADVANCE RECEIVING

For advance receiving, mail or fax the Material Handling Order Form & Invoice with pre-payment to LEVY EXPOSITION SERVICES INC. Shipments sent collect **WILL NOT** be accepted.

Advance receiving includes the following:

- receiving your material at the warehouse up to thirty days in advance of the move-in day
- delivering the shipment to your booth at the facility
- removing empty crates from your booth to a designated storage area
- returning your empty crates to your booth at the close of the show
- loading your crates onto your designated carrier at the close of the show

The material handling services provided by LEVY EXPOSITION SERVICES INC. end with the close of the show. It is the responsibility of the exhibitor to make appropriate arrangements with a carrier for shipping following the close of the show. Please make special note of the allotted move-out times and days, and confirm with your carrier that they are able to meet these allotted times.

Please remove all old shipping labels and ensure that all freight destined for the advance warehouse is labeled with the following information:

APSCON 2026
COMPANY NAME & BOOTH #
Levy Exposition Services Inc.
c/o LibertyCFS
12250 NW 28th Ave
Miami, FL 33167

Shipments may be sent to the advance warehouse up to thirty days prior to the move-in day for the show. All shipments however, must be received at the warehouse a minimum of one week (seven days) in advance of the show move-in date. Shipments received less than seven days prior to the move-in day are subject to extra charges and delivery time **will not** be guaranteed. All shipments must be received at the advance warehouse between the hours of 08:00 and 15:00, Monday to Friday, no earlier than **June 8, 2026** and no later than **July 6, 2026**. **Shipments that arrive prior to June 8, 2026 or after July 6, 2026 will be subject to the rate of \$3.95 per pound.**

ANY SHIPMENT(S) RECEIVED AT THE ADVANCE WAREHOUSE AFTER JULY 6, 2026 WILL INCUR A CHARGE OF \$750.00 IF A DEDICATED TRUCK IS REQUIRED TO DELIVER TO THE SHOW SITE.

Shipments must include an official weight ticket or bill of lading.

SHIPPING INSTRUCTIONS (CONT'D.)

SHOW-SITE RECEIVING

For show-site receiving, mail or fax the Material Handling Order Form & Invoice with pre-payment to LEVY EXPOSITION SERVICES INC. Shipments sent collect **WILL NOT** be accepted.

Show-site receiving includes the following:

- receiving and signing for your shipment on your behalf
- delivering the shipment to your booth at the facility
- removing empty crates from your booth to a designated storage area
- returning your empty crates to your booth at the close of the show
- loading your crates onto your designated carrier at the close of the show

The material handling services provided by LEVY EXPOSITION SERVICES INC. end with the close of the show. It is the responsibility of the exhibitor to make appropriate arrangements with a carrier for shipping following the close of the show. Please make special note of the allotted move-out times and days, and confirm with your carrier that they are able to meet these allotted times.

Please remove all old shipping labels and ensure that all freight destined for show-site receiving is labeled with the following information:

APSCON 2026
COMPANY NAME & BOOTH #
Broward County Convention Center
c/o Levy Exposition Services Inc.
1950 Eisenhower Blvd
Fort Lauderdale, FL

PLEASE NOTE THAT SHIPMENTS CANNOT BE RECEIVED AT THE BROWARD COUNTY CONVENTION CENTER PRIOR TO 8:00 AM ON MONDAY, JULY 13, 2026.

ALL SHIPMENTS MUST INCLUDE A CERTIFIED WEIGHT TICKET OR BILL OF LADING. IN THE EVENT THAT YOUR SHIPMENT(S) DOES NOT INCLUDE A CERTIFIED WEIGHT TICKET, IT WILL BE WEIGHED ON-SITE AND A SURCHARGE OF \$0.25 PER POUND WILL BE APPLIED.

LIMITS OF LIABILITY

See Material Handling Terms & Conditions Sheet enclosed.

MATERIAL HANDLING

Acceptance of said terms and conditions will be constructed when any of the following conditions are met:

- ~ **THE MATERIAL HANDLING ORDER FORM AND INVOICE IS SIGNED; OR**
- ~ **WHEN EXHIBITOR'S MATERIALS ARE DELIVERED TO LES'S WAREHOUSE OR TO A SHOW/ EXPOSITION SITE FOR WHICH LEVY EXPOSITION SERVICES INC. IS THE OFFICIAL SHOW CONTRACTOR; OR**
- ~ **WHEN AN ORDER FOR LABOR AND/ OR RENTAL EQUIPMENT IS PLACED BY AN EXHIBITOR WITH LEVY EXPOSITION SERVICES INC.**

1. **DEFINITIONS.** "Levy Exposition Services Inc" ("LES"), and any sub-contractors affiliated within the show.
2. **PACKAGING AND CRATES.** LES shall not be responsible for damage to loose, uncrated materials, pad-wrapped or shrink-wrapped materials, glass breakage, concealed damage, carpets in bags or poly, or materials improperly packed. In addition, LES shall not be responsible for crates and packaging which are unsuitable for handling, in poor condition, or have prior damage. Crated and packaging should be of a design to adequately protect contents for handling by forklift and similar means.
3. **EMPTY CONTAINERS.** Empty container labels will be available at the show site service desk. Affixing labels to the containers is the sole responsibility of EXHIBITOR or his representative. All previous labels must be removed or obliterated. LES assumes no responsibility for: Error in the above procedures; Removal of containers with old empty labels & without LES labels; or Improper information on empty labels. LES WILL NOT BE LIABLE FOR LOSS OR DAMAGE TO CRATES AND CONTAINERS OR THEIR CONTENTS WHEN SAID ITEMS ARE IN EMPTY CONTAINER STORAGE.
4. **INBOUND SHIPMENT(S).** Consistent with trade show industry practices, there may be a lapse of time between the delivery of shipment(s) to the booth and the arrival of EXHIBITOR or his representative, and during such time the materials will be left unattended. LES WILL NOT BE RESPONSIBLE OR LIABLE FOR ANY LOSS, DAMAGE, THEFT, OR DISAPPEARANCE OF EXHIBITOR'S MATERIALS AFTER SAME HAVE BEEN DELIVERED TO EXHIBITOR'S BOOTH AT SHOW SITE. LES highly recommends the securing of security services for Facility or Show Management.
5. **OUTBOUND SHIPMENT(S).** Consistent with trade show industry practices, there may be a lapse of time between the completions of packing and the actual pickup of materials from the booths for loading onto a carrier and during such time the materials will be left unattended. LES WILL NOT BE RESPONSIBLE OR LIABLE FOR ANY LOSS, DAMAGE, THEFT, OR DISAPPEARANCE OF EXHIBITOR'S MATERIALS BEFORE SAME HAVE BEEN PICKED UP FOR RELOADING AT THE CONCLUSION OF THE EVENT. LES highly recommends the securing of security services from Facility or Show Management. All Material Handling Agreements submitted to LES by EXHIBITOR will be checked at the time of pickup from booth and corrections will be made where discrepancies exist between the quantities of times listed by EXHIBITOR and the actual count of such items in the booth at the time of pickup.
6. **LES'S RESPONSIBILITIES.** LES shall be responsible only for those services which it directly provides. LES assumes no responsibility for any persons, parties, or other contracting firms not under LES's direct supervision and control. LES shall not be responsible for loss, delay, or damage due to strike, lockouts, work stoppages, natural elements, vandalism, acts of God, civil disturbances, power failure, explosion, acts of terrorism or war, other causes beyond LES's reasonable control, nor for ordinary wear & tear in the handling of materials.
7. **INSURANCE.** It is understood that LES is not an insurer. Insurance on exhibit materials, if any, shall be obtained by EXHIBITOR in amounts and for perils determined by EXHIBITOR. EXHIBITOR agrees to provide LES with a release of subrogation to the extent of any insurance settlement received.
8. **CLAIM(S) FOR LOSS.** Claims for loss or damage must be reported at show-site.
 - A. **PAYMENT FOR SERVICES MAY NOT BE WITHHELD.** In the event of any dispute between the EXHIBITOR shall not be entitled to and shall not withhold payment, or any partial payment due to LES for its services, as an offset against the amount of any alleged loss or damage.
 - B. **MAXIMUM RECOVERY.** If found damaged LES's sole and exclusive MAXIMUM liability for loss or damage to EXHIBITOR's materials and EXHIBITOR's sole and exclusive remedy is limited to \$.50 per pound article with a maximum liability of \$100.00 per item, or \$1,500.00 per shipment.
9. **JURISDICTION.** THIS CONTRACT SHALL BE CONSTRUED UNDER THE LAWS OF THE STATE OF FLORIDA WITHOUT GIVING EFFECT TO ITS CONFLICT OF LAWS RULES. EXCLUSIVE VENUE FOR ALL DISPUTES ARISING OUT OF OUR RELATING TO THIS CONTRACT SHALL RESIDE IN A COURT OF COMPETENT JURISDICTION IN FORT LAUDERDALE, FLORIDA.
10. **INDEMNIFICATION.** EXHIBITOR agrees to indemnify, forever hold harmless and defend LES, its employees, directors, officers, and agents from and against any and all demands, claims, causes of action, fines, penalties, damages (including consequential), liability, judgments, and expenses (including but not limited to reasonable attorney's fees and investigation costs) on account of personal injury, death, or damage to or loss of property or profits arising out of, or contributed to, by any of the following:
 - EXHIBITOR's negligent supervision of any labor secured through LES, or the negligent supervision of such labor by any of EXHIBITOR's employees, agents, representative, customers, invitees and/or Exhibitor Appointed Contractor (EAC).
 - EXHIBITOR's negligence, willful misconduct, or deliberate act of EXHIBITOR's employees, agents, representatives, customers, invitees and/or any Exhibitor Appointed Contractor (EAC) at the show or exposition to which this contract relates.
 - EXHIBITOR's violation of U.S.A. or Local ordinances or the violation of Show Regulations and/or Rules as published and set forth by Facility and/or Show Management.
 - EXHIBITOR's inclusion of illegal substances, hazardous materials or waste in any shipment placed with LES and for the violation of the representations and warranties made regarding hazardous materials made on the front of this Agreement.
11. **MISCELLANEOUS.** EXHIBITOR, as a material part of the consideration LES for material handling and transportation services, waives and releases all claims against LES, its employees, agents, officers, and directors, with respect to all matters for which LES has disclaimed liability pursuant to the provisions of this contract. The EXHIBITOR acknowledges that he or she has read this agreement, understands it and agrees to be bound by its terms, and further agrees that it is the complete and exclusive agreement between the parties. The invalidity or enforceability of any provision hereof shall not affect, modify, or impair the validity and enforceability of all provisions herein.



ADVANCE WAREHOUSE

ADVANCE WAREHOUSE

TO: _____
(EXHIBITOR NAME)

TO: _____
(EXHIBITOR NAME)

BOOTH # _____

BOOTH # _____

**Levy Exposition Services Inc.
c/o LibertyCFS
12250 NW 28th Ave
Miami, FL 33167**

**Levy Exposition Services Inc.
c/o LibertyCFS
12250 NW 28th Ave
Miami, FL 33167**

EVENT NAME:

APSCON 2026

EVENT NAME:

APSCON 2026

NO. _____ # of _____ PCS.

NO. _____ # of _____ PCS.

The above labels are provided for your convenience.
Place one on each piece shipped to the ADVANCE WAREHOUSE.
If more labels are needed, copies are acceptable.



SHOW SITE

TO: _____
(EXHIBITOR NAME)

BOOTH # _____

**Broward County Convention Center
c/o Levy Exposition Services Inc.
1950 Eisenhower Blvd
Fort Lauderdale, FL 33316**

EVENT NAME:

APSCON 2026

NO. _____ # of _____ PCS.



SHOW SITE

TO: _____
(EXHIBITOR NAME)

BOOTH # _____

**Broward County Convention Center
c/o Levy Exposition Services Inc.
1950 Eisenhower Blvd
Fort Lauderdale, FL 33316**

EVENT NAME:

APSCON 2026

NO. _____ # of _____ PCS.

The above labels are provided for your convenience.
Place one on each piece shipped to the SHOW SITE.
If more labels are needed, copies are acceptable.



MOVE YOUR EXHIBIT WITH PEACE OF MIND

THE FREIGHT & CUSTOMS PARTNER YOU CAN RELY ON
FULLY DEDICATED TO YOUR CONVENTION AND TRADE SHOW SUCCESS

Putting service first and leveraging our 42 years of freight & customs experience



Transportation Services

- Ground Freight (LTL)
- Full Load
- International Freight Forwarding
- Customs Brokerage Services
- Exclusive Use Full Trailer



Customized Solutions

- Door to door service
- Catering to your specific needs
- Single point of contact
- 24/7 customer attention
- Committed to excellence

Dedicated to delivering safely and on time every time.

Call Toll Free 1-866-938-1092 or 1.905.338.3993
email: exhibitorservices@libertycfs.us - www.libertycfs.us

LAS VEGAS | TORONTO





FREIGHT & CUSTOMS ORDER FORM

1 Please accept this form as authority for LibertyCFS NV, Inc. to provide the services listed below. A second form is required for additional events.

Adobe Acrobat Reader DC may be required for completion of form. Click image to download 

Freight Only	Customs Only	Freight & Customs	Return Only
--------------	--------------	-------------------	-------------

<p>2a PICK-UP LOCATION</p> <p>Company Name _____</p> <p>Address1 _____</p> <p>Address2 _____</p> <p>City _____ State _____ ZipCode _____</p> <p>Contact _____ Phone # _____</p> <p>Email _____ IRS/Tax ID# _____</p>	<p>3 DELIVERY TO ADDRESS</p> <p>Exhibiting Company Name _____ Booth # _____</p> <p>Show Name _____</p> <p>Address1 _____</p> <p>Address2 _____</p> <p>City _____ State _____ ZipCode _____</p> <p>Onsite Contact _____ Cell Phone # _____</p>
--	---

<p>2b SERVICES</p> <p>P/U Date _____ From _____ To _____</p> <p>Hours _____</p> <p>Dlvy Date _____ Hours _____</p> <p>Express Economy LTL 5-7 Days Int'l</p> <p>Inside Liftgate Dock</p> <p>Other _____</p>	<p>4 RETURN TO</p> <p><input type="checkbox"/> Check Box if the Return address is the same as 2a</p> <p>Consignee: _____</p> <p>Address1 _____</p> <p>Address2 _____</p> <p>City _____ State _____ ZipCode _____</p> <p>Contact _____ Phone # _____</p> <p>PU Date _____ Arrive by _____</p>
---	--

<p>5 PACKAGE INFO</p> <p>Carton(s)/Box _____</p> <p>Vinyl Case(s)/Color _____</p> <p>Wooden Crate(s) _____</p> <p>Trunk(s) / On Wheels _____</p> <p>Skid(s) - to contain # _____ of pieces</p>	<table border="1" style="width: 100%; border-collapse: collapse;"> <thead> <tr> <th style="width: 10%;">PCS</th> <th style="width: 70%;">DIMENSIONS (L x W x H)</th> <th style="width: 20%;">WGT</th> </tr> </thead> <tbody> <tr><td> </td><td> </td><td> </td></tr> <tr><td> </td><td> </td><td> </td></tr> <tr><td> </td><td> </td><td> </td></tr> <tr><td> </td><td> </td><td> </td></tr> <tr><td> </td><td> </td><td> </td></tr> <tr><td> </td><td> </td><td> </td></tr> <tr><td> </td><td> </td><td> </td></tr> <tr><td> </td><td> </td><td> </td></tr> <tr><td> </td><td> </td><td> </td></tr> <tr> <td colspan="2" style="text-align: right;">TOTAL PIECES</td> <td>TOTAL WEIGHT</td> </tr> </tbody> </table>	PCS	DIMENSIONS (L x W x H)	WGT																												TOTAL PIECES		TOTAL WEIGHT
PCS	DIMENSIONS (L x W x H)	WGT																																
TOTAL PIECES		TOTAL WEIGHT																																



6 **Declared Value - Full Value Coverage:** *The declared value will be defined as commercial value of the goods for new cargo or actual cash value or replacement value for used items plus 10%*

The following are not eligible for Full Value coverage: *Televisions/monitors, Concealed Damages and concealed shortages, Loss arising from wear, tear, gradual deterioration, depreciation, or inherent vice, Any mechanical, electrical, electronic, digital breakdown or derangement unless caused by an accident during the coverage period*

COST of COVERAGE: *Minimum Charge \$150, \$5.00 per \$100 of coverage, up to \$50,000* **VALUE COVERED**

7 **PAYMENT**

Credit Card Information / Billing Address

Credit Card Number _____ Security Code _____ Exp. Date MM / YYYY

I hereby authorize the use of this card for payment of services related to this Order Form. I understand that declined credit cards are subject to a 30% surcharge.

Address _____ Signature _____

City _____ State _____ ZipCode _____

Phone _____ Email _____

Comments: Include any additional comments that will be helpful for the movement of freight and contents



PRODUCT

CATALOG

Special Events | Trade Shows | Corporate Functions

Specialty Furniture Rental >>



253-437-0031

www.levyexpo.com





FULTON Sofa
Black Leather
80"L x 31"D x 32"H
120 lbs



FULTON Love Seat
Black Leather
57"L x 31"D x 32"H
88 lbs



FULTON Chair
Black Leather
33"L x 31"D x 32"H
54 lbs



VERONA SOFA
WHITE Leather
78"L x 28.75"D x 28.25"H
128 lbs



VERONA LOVE SEAT
White Leather
57"L x 28.75"D x 28.25"H
100 lbs



VERONA Chair
White Leather
27"L x 35"D x 28.75"H
68 lbs

Lounge



DEIRA Curved Sofa
White Leather
82"L x 34"D x 31"H



DEIRA Reversed Curved Love Seat
White Leather
72"L x 34"D x 31"H



DEIRA Curved Bench
White Leather
70"L x 26"D x 19"H



DEIRA Round Ottoman
White Leather
39" Dia x 17"H



DEIRA RECTANGLE OTTOMAN
White Leather
60"L x 27"D x 19"H



ETERNITY Mod Lounge



ETERNITY Mod Chair
White Leather
28"L x 28"D x 36"H



ETERNITY Mod Wedge
White Leather
26"L x 28"D x 17"H

Lounge

LEVY

EXPOSITION SERVICES INC.



AVENDALE Sofa
Beige Upholstery
90"L X 34.5"D X 34"H



AVENDALE Love Seat
Beige Upholstery
78"L X 34.5"D X 34"H



AVENDALE Chair
Beige Upholstery
40"L X 34.5"D X 34"H



BRISBANE Love Seat | Grey Upholstered
65"L X 30"D X 31"H



BRISBANE Chair | Grey Upholstered
30"L X 30"D X 32"H

Lounge



**KENWOOD Love Seat | Light Beige
Linen Upholstery**
63"L X 29"D X 34"H



**KENWOOD Chair | Light Beige
Linen Upholstery**
27"L X 27"D X 34"H



**NAPLES Sofa
Yellow Upholstery**
70"L X 29"D X 32"H



**NAPLES Love Seat
Yellow Upholstery**
50"L X 29"D X 32"H



**NAPLES Chair
Yellow Upholstery**
31"L X 29"D X 32"H



Lounge



**LAGUNA Armless Chair
White Cushion**
28"L x 35"D x 29"H, 34 lbs



**LAGUNA Ottoman
White Cushion**
28"L x 28"D x 19"H, 19 lbs



**LAGUNA Corner Chair
White Cushion**
35"L x 35"D x 29"H, 79 lbs



CYPRESS Cocktail Table
35.5"L x 35.5"D x 18.5"H, 45 lbs



LAGUNA Tree Stump End Table
18"L x 15"D x 16.5"H, 19 lbs



**LAGUNA Armless Chair
Wheat Cushion**
28"L x 35"D x 29"H, 34 lbs



**LAGUNA Ottoman
Wheat Cushion**
28"L x 28"D x 19"H, 19 lbs



**LAGUNA Corner Chair
Wheat Cushion**
35"L x 35"D x 29"H, 79 lbs



Outdoor Lounge



MADISON Cocktail Table
White Marble
44"L x 20"D x 18"H, 20 lbs



MADISON End Table
White Marble
24"L x 20"D x 22"H, 10 lbs



MADISON Cocktail Table
Black Marble
44"L x 20"D x 18"H, 20 lbs



MADISON End Table
Black Marble
24"L x 20"D x 22"H, 10 lbs



SYDNEY Cocktail Table
Glass / Chrome
47"L x 23"D x 17"H, 26 lbs



SYDNEY End Table
Glass / Chrome
20"L x 20"D x 19"H, 21 lbs



ALTON Cocktail Table | White / Chrome
****Charged**
44"L x 22"D x 15"H, 25 lbs



VAN GOGH End Table
13"L x 13"D x 18"H, 10 lbs



WINDSOR End Table
Yellow
17"L x 17"D x 24"H, 12 lbs



WHITNEY End Table | Gold
22"L x 22"D x 28.8"H, 15 lbs



CLASSIC Side Table
White / Chrome
18"L x 16"D x 25"H, 10 lbs

Cocktails / Ends Tables



CATO Cube Ottoman
White Leather
17.5"L x 17.5"D x 16.5"H



CATO Cube Ottoman
Black Leather
17.5"L x 17.5"D x 16.5"H



White Swivel Ottoman
White Leather
18"L x 18"D x 18"H



DEIRA Curved Bench
White Leather
70"L x 26"D x 19"H



DEIRA RECTANGLE OTTOMAN
White Leather
60"L x 27"D x 19"H



DEIRA Round Ottoman
White Leather
39"Dia x 17"H



Ottomans / Benches



NOVA Armless Chair | White / Chrome
18"L x 22"D x 36"H



NOVA Armless Chair | Black / Chrome
18"L x 22"D x 36"H



LLOYD Chair | White / Chrome
22"L x 19"D x 33"H



EAMES Chair | White - Wooden Legs
18"L x 17"D x 32"H



GUN METAL Chair | Gray
19"L x 18"D x 33"H



CONSTANTINE Stage Chair
White
30"L x 30"D x 38"H



TWILIGHT Stage Chair
Black
27.5"L x 25.5"D x 28"H



SIERRA Stage Chair
White
26"L x 23"D x 35"H

Occasional Chairs



**31" Dia. Short Cafe Table
Glass / Chrome**
31.5"Dia x 29"H, 48 lbs



**30" Dia. Short Cafe
Table Black**
30"Dia x 31"H, 39 lbs



**Short Cafe Table | White /
Chrome**
30" Dia. - 30"Dia x 29"H, 39 lbs
36" Dia. - 36"Dia x 29"H, 46 lbs



**30" Dia. Short Cafe Table
Black / Chrome**
30"Dia x 29"H, 39 lbs



Short Tulip Cafe Table | White
30" Dia. - 30"Dia x 30"H, 30 lbs
42" Dia. - 42"Dia x 30"H, 47 lbs



**31.5" EAMES Table White
Wood Legs**
31.5"Dia x 29"H, 21 lbs



36" Dia. X Base Glass Dining Table
Glass / Chrome
36" Dia x 30"H"



Short Cafe' / Glass Dining Tables



NEO Bar Stool | White | Black | Red
17"L x 18"D x 37-45.25"H
Adjustable / Swivel



GIOVANNI Mid Back Bar Stool | White | Black
20"L x 18"D x 36.75-45.25"H
Adjustable / Swivel



DAWSON Curve Bar Stool | White
15"L x 15"D x 31-35"H, 35 lbs
Adjustable / Swivel



DAWSON Curve Bar Stool | Black
15"L x 15"D x 31-35"H, 35 lbs
Adjustable / Swivel



ASHTON Swivel Bar Stool | White
21"L x 21"D x 32-40"H
Adjustable / Swivel



ASHTON Swivel Bar Stool | Black
21"L x 21"D x 32-40"H
Adjustable / Swivel

Bar Stools



NOVA Bar Stool | White /Chrome
17"L x 20"D x 41"H



ELON Bar Stool | White / Chrome
17"L x 16"D x 43"H



GUN METAL Bar Stool | Gray
20.5"L x 20"D x 46"H, 15 lbs



GUN METAL Bar Stool | Gray
17"L x 17"D x 30"H, 10 lbs



HAYWARD Bar Stool | White / Natural
20"L x 18"D x 29.5"H



Bar Stools



23" Dia. Tall Bar Table
Glass / Chrome
23.75"Dia x 41.75"H, 27 lbs

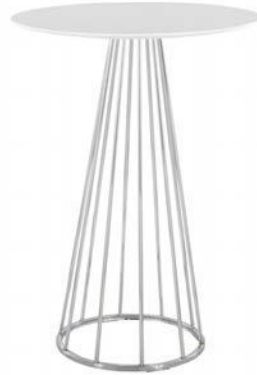

30" Dia. LENUX Table
White / Chrome Cage Base
30"Dia x 42"H



30" Dia. Tall Bar Table
White / Chrome Fluted Base
30"Dia x 26-41"H, 50 lbs



30" Dia. Tall Bar Table
Black / Chrome Fluted Base
30"Dia x 26-41"H, 50 lbs



30" Dia. Tall Bar Table
Black / Black
30"Dia x 42"H, 47 lbs



Tall Bar Table
White / Chrome
30" - 30"Dia x 42"H, 54 lbs
36" - 36"Dia x 42"H, 64 lbs



30" Dia. Tall Bar Table
Black / Chrome
30"Dia x 42"H, 54 lbs



Tall Bar Tables



Reception Counter | White
47.75"L x 19.5"D x 42.75"H, 95 lbs



Reception Counter | Black
47.75"L x 19.5"D x 42.75"H, 95 lbs



***Branding Available**



5' MADISON Pub Table
White / Silver Base
60"L x 23"D x 42"H, 75 lbs



5' MADISON "CHARGED" Pub Table
White / Silver Base
60"L x 23"D x 42"H, 80 lbs



4.75' COMMUNAL Table | White
4.75'L x 23.75"D x 40"H, 108 lbs



5' LED GLOW Table
60"L x 24"D x 40"H, 90 lbs



Reception Counters / Pub Tables

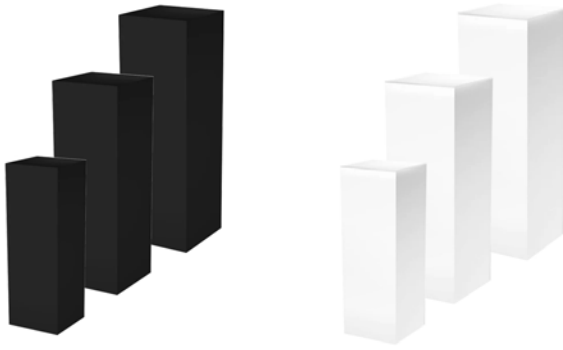

Display Pedestals | Black or White

Available in 3 Sizes:

12"L x 12"D x 30"H

18"L x 18"D x 36"H

18"L x 18"D x 42"H



***Branding Available**

42" LOCKING Pedestal Cabinet | Black
24"L x 24"D x 42"H



***Branding Available**

42" LOCKING Pedestal Cabinet | White
24"L x 24"D x 42"H



***LED Lighted option also available**

6' VIP Straight Bar *Branding Available
White Acrylic / Polished Silver
72"L x 24"D x 42"H



6' DIAMOND Straight Bar
White Acrylic / Polished Silver Design
72"L x 30"D x 40"H *Shown Below

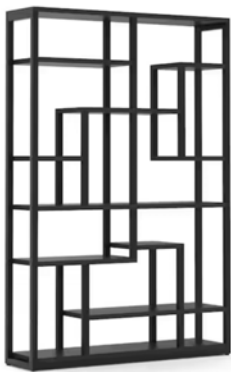

Black Etagere / Back Bar - 10 Shelf
47"L x 11"D x 70"H



White Etagere / Back Bar - 9 Shelf
37.4"L x 11.8"W x 69"H



***Set of 2 shown above**

Pedestals & Bars



6' SUMMIT Table
White / Silver Base
72"L x 30"D x 30"H, 122 lbs



DISTRICT 8' Conference Table
Grey / Black & Silver Base
96"L x 47"D x 27.5"H, 138 lbs



ABERDEEN 8' Conference Table
Grey
96"L x 48"D x 29.5"H, 322 lbs

ABERDEEN 10' Conference Table
Grey
120"L x 48"D x 29.5"H, 322 lbs



COMMODORE EXECUTIVE CHAIR
Black / Chrome
Seat Adjust from 17" to 21"H



COMMODORE EXECUTIVE CHAIR
White / Chrome
Seat Adjust from 17" to 21"H



EXECUTIVE GUEST CHAIR | Black
27"L x 27"D x 40"H



TASK CHAIR w/ Arms | Black
Seat Adjust from 17" to 22"H



DRAFTING STOOL | Black
Seat Adjust from 22" to 32"H



Office



8' FOLIAGE Backdrop Wall
8'L x 24"D x 8'H



16' FOLIAGE Backdrop Wall
16'L x 24"D x 8'H

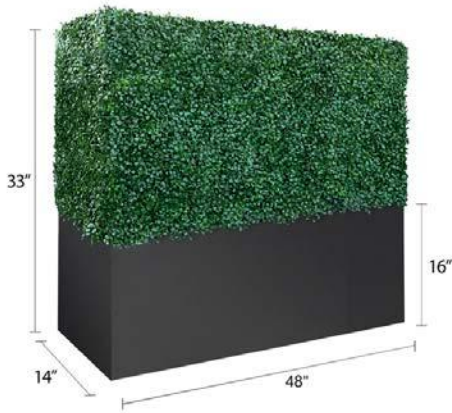

33''H Box Hedge Wall
48"L x 14"D x 33"H

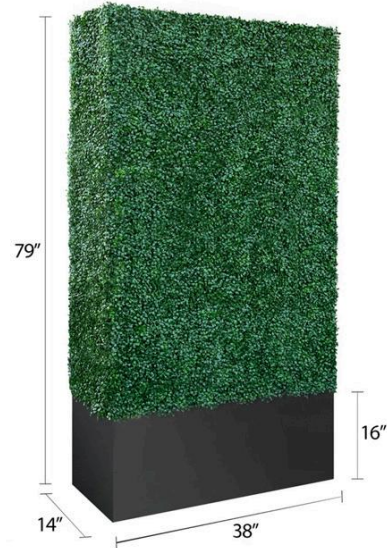

79''H Box Hedge Wall
38"L x 14"D x 79"H



**Stanchion Pole
Chrome**
12"L x 37"H



Stanchion Velvet Rope
5' Rope Available in Black or Orange
6.6' Rapoe Available in Blue



**Retractable Belt
Stanchion | Black**
40"H - Belt extends up to 11'

Accessories



GLOW Cube | Adjustable Colors
20"L x 20"D x 20"H



Refrigerator
20"L x 20"D x 34"H
3.3 CuFt | 110 Volts / 155.25 Watts



Bag Rack | Chrome
45"H | 16" Straight Arm

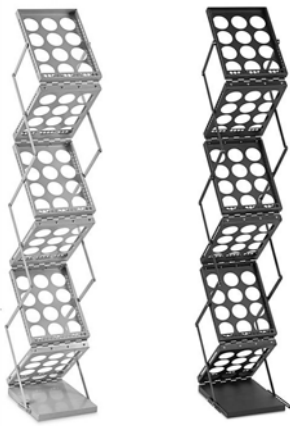

6 Pocket Literature Stand
Silver or Black
10.75"L x 14.25"D x 58"H



LIGHTED MARQUEE LETTERING
White Letters | Clear LED Bulbs
3 ft. Tall | Standard 110 electric required



Coat Rack | Black
12.6"W x 67"H



Floor Lamp | Black
71"H



Free Standing Mirror
24"L x 24.5" D x 64"H



Throw Pillows
Various Colors
13"L x 13"W

Accessories



LEVY
EXPOSITION SERVICES INC.
www.levyexpo.com



Email Orders to: operations@levyexpo.com
 Fax: 253 437 0032
 Phone: 253 437 0031



Company Information				Delivery Information			
Company Name:				Event:			
Address:				Location:			
Phone:				Booth #:			
E-Mail:				Delivery Date/Time:			
OnSite Contact:				Strike Date/Time:			
				Event Start Date/Time:			
				Event End Date/Time:			

*Orders received after 3 weeks prior to event are based on availability and subject to a 30% Late Fee.

*25% cancellation will be applied to all orders received and canceled 3 weeks prior to install.

*100% cancellation will be applied if canceled on day of delivery.

*Check or Credit Card must accompany order. Payment required prior to delivery.

*A 2.0% Credit Card Fee will be applied to all credit card payments

Items missing or returned damaged are subject to replacement charges.

ITEM NAME	DIMENSIONS	EVENT RATE	Qty.	Total
Lounge Sofas / Love Seats / Chairs				
VERONA White Leather Sofa	78"L x 28.75"D x 28.25"H	\$929.00		\$
VERONA White Leather Love Seat	57"L x 28.75"D x 28.25"H	\$838.00		\$
VERONA White Leather Chair	27"L x 35"D x 28.75"H	\$576.00		\$
FULTON Black Leather Sofa	80"L x 31"D x 32"H	\$929.00		\$
FULTON Black Leather Love Seat	57"L x 31"D x 32"H	\$838.00		\$
FULTON Black Leather Chair	33"L x 31"D x 32"H	\$576.00		\$
AVENDALE Upholstered Sofa / Beige	90"L X 34.5"D X 34"H	\$929.00		\$
AVENDALE Upholstered Love Seat / Beige	78"L X 34.5"D X 34"H	\$838.00		\$
AVENDALE Upholstered Chair / Beige	40"L X 34.5"D X 34"H	\$576.00		\$
BRISBANE Upholstered Love Seat / Grey	65"L x 30"D x 31"H	\$929.00		\$
BRISBANE Upholstered Chair / Grey	30"L x 30"D x 32"H	\$576.00		\$
KENWOOD Upholstered Love Seat / Light Beige	63"L x 29"D x 34"H	\$838.00		\$
KENWOOD Upholstered Chair / Light Beige	27"L x 27"D x 34"H	\$576.00		\$
NAPLES Upholstered Sofa / Yellow	70.5"L x 29"D x 32"H	\$1086.00		\$
NAPLES Upholstered Love Seat / Yellow	50.8"L x 29"D x 32"H	\$996.00		\$
NAPLES Upholstered Chair / Yellow	31"L x 29"D x 32"H	\$663.00		\$
DEIRA Curved Sofa / White Leather	82"L x 34"D x 31"H	\$1014.00		\$
DEIRA Reversed Curved Love Seat / White Leather	72"L x 34"D x 31"H	\$984.00		\$
DEIRA Curved Bench / White Leather	70"L x 26"D x 19"H	\$617.00		\$
DEIRA Round Ottoman / White Leather	39"Dia x 17"H	\$470.00		\$
DEIRA Rectangle Ottoman / White Leather	60"L x 27"D x 19"H	\$470.00		\$
ETERNITY Mod Lounge Chair	28"L x 28"D x 36"H	\$473.00		\$
ETERNITY Mod Lounge Wedge	26"L x 28"D x 17"H	\$390.00		\$
LAGUNA OUTDOOR Armless Chair / White	28"L x 35"D x 29"H	\$446.00		\$
LAGUNA OUTDOOR Corner / White	35"L x 35"D x 29"H	\$473.00		\$
LAGUNA OUTDOOR Ottoman / White	28"L x 28"D x 19"H	\$273.00		\$
LAGUNA OUTDOOR Armless Chair / Wheat	28"L x 35"D x 29"H	\$446.00		\$
LAGUNA OUTDOOR Corner / Wheat	35"L x 35"D x 29"H	\$473.00		\$
LAGUNA OUTDOOR Ottoman / Wheat	28"L x 28"D x 19"H	\$273.00		\$
Cocktail / End Tables				
MADISON Cocktail Table / White	44"L x 20"D x 18"H	\$320.00		\$
MADISON Cocktail Table / Black	44"L x 20"D x 18"H	\$320.00		\$
MADISON End Table / White	24"L x 20"D x 22"H	\$314.00		\$
MADISON End Table / Black	24"L x 20"D x 22"H	\$314.00		\$
ALTON Cocktail Table / White (Charged)	44"L x 22"D x 15"H	\$482.00		\$
SYDNEY Glass Cocktail Table / Chrome	47"L x 23"D x 17"H	\$368.00		\$
SYDNEY Glass End Table / Chrome	20"L x 20"D x 19"H	\$314.00		\$
CYPRESS Cocktail Table	35.5"L x 35.5"D x 18.5"H	\$347.00		\$
LAGUNA Tree Stump End Table	18"L x 15"D x 16.5"H	\$326.00		\$
WHITNEY End Table - Gold	22"D x 22"W x 28.8"H	\$326.00		\$
WINDSOR End Table - Yellow	17"D x 17"W x 24"H	\$326.00		\$
CLASSIC End Table - White / Chrome	19.75"L x 11.75"D x 23.75"H	\$167.00		\$

VAN GOGH End Table - Chrome	13"L x 13"D x 18"H	\$178.00		\$
Ottomans / Benches				
CATO Cube Ottoman / White	17.5"L x 17.5"D x 16.5"H	\$173.00		\$
CATO Cube Ottoman / Black	17.5"L x 17.5"D x 16.5"H	\$173.00		\$
White Swivel Ottoman / White	18"L x 18"D x 18"H	\$173.00		\$
DEIRA Round Ottoman / White Leather	39"Dia x 17"H	\$470.00		\$
DEIRA Rectangle Ottoman / White Leather	60"L x 27"D x 19"H	\$470.00		\$
DEIRA Curved Bench / White Leather	70"L x 26"D x 19"H	\$617.00		\$
Occasional Chairs				
NOVA Chair / White - Chrome	18"L x 22"D x 36"H	\$234.00		\$
NOVA Chair / Black - Chrome	18"L x 22"D x 36"H	\$234.00		\$
LLOYD Chair / White - Chrome	22"L X 19"W X 33"H	\$234.00		\$
EAMES Chair / White - Natural Wooden Legs	18"L x 17"D x 32"H	\$248.00		\$
EAMES Chair / White - Chrome Legs	22.5"L x 18"D x 32"H	\$248.00		\$
Gun Metal Chair - Grey	19"L x 18"D x 33"H	\$234.00		\$
CONSTANTINE Stage Chair / White	30"L x 30"D x 38"H	\$558.00		\$
SIERRA Stage Chair / White	26"L x 23"D x 35"H	\$361.00		\$
TWILIGHT Stage Chair / Black	27.5"L x 25.5"D x 28"H	\$513.00		\$
Short Café / Dining Tables				
30" Dia. Short Café Table - Black / Black Base	30" Dia x 29"H	\$258.00		\$
30" Dia. Short Café Table - White / Chrome Base	30" Dia x 29"H	\$332.00		\$
30" Dia. Short Café Table - Black / Chrome Base	30" Dia x 29"H	\$332.00		\$
31" Dia. Short Glass Café Table / Chrome Base	31"Dia x 29"H	\$293.00		\$
30" Dia. Short Tulip Café Table - White	30" Dia x 30"H	\$318.00		\$
30" Dia. EAMES Table / White - Chrome Steel Legs	30"Dia. x 29"H	\$293.00		\$
31.5" Dia. EAMES Table / White - Wooden Legs	31.5"Dia. x 29"H	\$293.00		\$
36" Dia. Short Café Table - White / Chrome X Base	36" Dia x 29"H	\$381.00		\$
36" Dia. Glass / Dining Table - Chrome X Base	36" Dia x 30"H	\$318.00		\$
42" Dia. Short Tulip Café Table - White	42" Dia x 30"H	\$381.00		\$
Tall Bar Tables				
23" Dia. Glass Tall Bar Table - Chrome Fluted Base	23.75"Dia. x 42"H	\$381.00		\$
30" Dia. Bar Table / White - Chrome Fluted Base	30"Dia x 26"-41"H (<i>Adjustable</i>)	\$367.00		\$
30" Dia. Tall Bar Table / Black - Chrome Fluted Base	30"Dia x 26"-41"H (<i>Adjustable</i>)	\$367.00		\$
30" Dia Bar Table / White - Chrome X Base	30"Dia x 42"H	\$367.00		\$
30" Dia. Tall Bar Table / Black - Chrome X Base	30"Dia x 42"H	\$367.00		\$
30" Dia. Tall Bar Table / Black - Black X Base	30"Dia x 42"H	\$336.00		\$
36" Dia. Tall Bar Table / White - Chrome X Base	36"Dia x 42"H	\$402.00		\$
30" Dia. LENUX Tall Bar Table / White - Chrome Cage Base	30"Dia x 42"H	\$367.00		\$
Bar Stools				
ASHTON Swivel Stool / White - Chrome	15"L x 15"D x 24.5"-29.5"H (<i>Adjustable</i>)	\$264.00		\$
ASHTON Swivel Stool / Black - Chrome	15"L x 15"D x 24.5"-29.5"H (<i>Adjustable</i>)	\$264.00		\$
HAYWARD Bar Stool / Natural - White	20"L x 18"D x 29.5"H	\$264.00		\$
DAWSON Curve Bar Stool / White - Chrome	15"L x 15"D x 31"-35"H (<i>Adjustable</i>)	\$264.00		\$
DAWSON Curve Bar Stool / Black - Chrome	15"L x 15"D x 31"-35"H (<i>Adjustable</i>)	\$264.00		\$
NOVA Bar Stool - White - Chrome	17"L x 20"D x 41"H	\$264.00		\$
ELON Bar Stool - White - Chrome	17"L x 16"D x 43"H	\$264.00		\$
NEO Bar Stool / White - Chrome - Armless	17"L x 18"D x 37"-45.25"H (<i>Adjustable</i>)	\$293.00		\$
NEO Bar Stool / Black - Chrome - Armless	17"L x 18"D x 37"-45.25"H (<i>Adjustable</i>)	\$293.00		\$
NEO Bar Stool / Red - Chrome - Armless	17"L x 18"D x 37"-45.25"H (<i>Adjustable</i>)	\$293.00		\$
GIOVANNI Mid Back Bar Stool / White - Swivel	21"L x 21"D x 32.7"-40.6"H (<i>Adjustable</i>)	\$293.00		\$
GIOVANNI Mid Back Bar Stool / Black - Swivel	21"L x 21"D x 32.7"-40.6"H (<i>Adjustable</i>)	\$293.00		\$

Gun Metal Bar Stool / Grey - Armless - Backless	17"L x 17"D x 30"H	\$264.00	\$
Gun Metal Bar Stool / Grey - w/ Back	20.5"L x 20"D x 46"H	\$293.00	\$
Display Pedestals			
12"x30" Display Pedestal / White	12"L x 12"D x 30"H	\$348.00	\$
12"x30" Display Pedestal / Black	12"L x 12"D x 30"H	\$348.00	\$
18"x36" Display Pedestal / White	18"L x 18"D x 36"H	\$418.00	\$
18"x36" Display Pedestal / Black	18"L x 18"D x 36"H	\$418.00	\$
18"x42" Display Pedestal / White	18"L x 18"D x 42"H	\$441.00	\$
18"x42" Display Pedestal / Black	18"L x 18"D x 42"H	\$441.00	\$
24"x42" Locking Pedestal / White	24"L x 24"D x 42"H	\$617.00	\$
24"x42" Locking Pedestal / Black	24"L x 24"D x 42"H	\$617.00	\$
Bars / Reception Counters / Pub Tables			
Reception Counter / White	47.75"L x 19.5D" x 42.75H"	\$537.00	\$
Reception Counter / Black	47.75"L x 19.5D" x 42.75H"	\$537.00	\$
4.75' Communal Table / White	57"L x 23.75"D x 40"H	\$732.00	\$
5' Madison Pub Table / White	60"L x 23"D x 42"H	\$819.00	\$
5' Madison Pub Table / White "Charged"	60"L x 23"D x 42"H	\$966.00	\$
5' LED GLOW Table	60"L x 24"D x 40"H	\$1433.00	\$
6' VIP Straight Bar - White Acrylic	72"L x 24"D x 42"H	\$1020.00	\$
6' VIP Straight Bar - White Acrylic -LED LIGHTED	72"L x 24"D x 42"H (Electrical Required)	\$1335.00	\$
6' DIAMOND Straight Bar - White Acrylic	72"L x 30"D x 42"H	\$1178.00	\$
6' DIAMOND Straight Bar - White Acrylic -LED LIGHTED	72"L x 30"D x 42"H (Electrical Required)	\$1492.00	\$
Office			
COMMODORE Leather Executive Chair / BLACK - Chrome	Seat Adjust from 17" to 21"H	\$429.00	\$
COMMODORE Leather Executive Chair / WHITE - Chrome	Seat Adjust from 17" to 21"H	\$429.00	\$
Mid-Back Leather Executive Guest Chair / Black	27"L x 27"D x 40"H	\$375.00	\$
Task Chair with Arms / Black	Seat Adjust from 19" to 24"H	\$293.00	\$
Drafting Stool / Black	Seat Adjust from 25" to 30"H	\$336.00	\$
2 Drawer Letter Size Filing Cabinet / Black	26"L x 14"D x 22"H	\$293.00	\$
6' SUMMIT Table / White & Silver	72"L x 30"D x 30"H	\$987.00	\$
8' DISTRICT Executive Conference Table / Grey & Black	95.2"L x 47.2"D x 27.5"H	\$1011.00	\$
8' ABERDEEN Executive Conference Table / Grey	96"L x 48"D x 29.5"H	\$987.00	\$
10' ABERDEEN Executive Conference Table / Grey	120"L x 48"D x 29.5"H	\$1128.00	\$
Accessories			
Glow Cube	20"L x 20"D x 20"H	\$338.00	\$
6 Pocket Literature Stand - Silver	10.75"L x 14.25"D x 58"H	\$270.00	\$
6 Pocket Literature Stand - Black	10.75"L x 14.25"D x 58"H	\$270.00	\$
Refrigerator / Black 3.3 CuFt (60Hz)	19"L x 17.6"D x 33.2"H	\$390.00	\$
Lighted Marquee Lettering / White	3' H w/ Clear LED Bulbs	\$300.00	\$
8' H Foliage Backdrop Wall	8'L x 24"D x 8'H	\$1480.00	\$
16' H Foliage Backdrop Wall	16'L x 24"D x 8'H	\$2437.00	\$
33"H Boxwood Hedge Wall	48"L x 14"D x 33"H	\$675.00	\$
79"H Boxwood Hedge Wall	38"L x 14"D x 79"H	\$795.00	\$
Stanchion Pole - Chrome	12"L x 37"H	\$95.00	\$
Stanchion Velvet Rope / Red	5'	\$60.00	\$
Retractable Belt Stanchion / Black	14"L x 40"H	\$112.00	\$
Bag Rack	45"H 16" Square Arm	\$82.00	\$
Coat Rack	12.6"D x 67"H	\$225.00	\$
Free Standing Mirror	24"W x 24.5"D x 64"H	\$293.00	\$
Floor Lamp - Black	71"H	\$195.00	\$
Throw Pillows (Various Colors)	18"L x 18"W	\$30.00	\$
Etagere / Back Bar / Black / 10 Shelf	47"L x 11"W x 70"H	\$727.00	\$
Etagere / Back Bar / White / 9 Shelf	37.4"L x 11.8"W x 69"H	\$577.00	\$

Credit Card Information			
Credit Card #:			
Exp. Date:	Security Code	Zip Code	
Mastercard	Visa	AMEX	Discover
Cardholders Name:			
(Please Print)			
Cardholders Signature:			

Total Product \$
Misc. \$
Late Fee % \$
Sub Total \$
Sales Tax \$
TOTAL DUE \$

Airborne Public Safety Association Annual Conference

July 16-17, 2026



BROWARD COUNTY
CONVENTION
CENTER

ELECTRICAL & PLUMBING

ORDER ONLINE TODAY!

Take advantage of discounted rates!

Order your electrical & plumbing services online by

06 / 25 / 2026

[ORDERING.EDLEN.COM](https://ordering.edlen.com)

Quick, secure, and easy to use!

You may receive an email to finalize your order from

ExhibitorServices-FtLauderdale@edlen.com

EDLEN
The Power People

Edlen Electrical Exhibition Services

16110 NW 13th Avenue, Miami, FL 33169

305.623.5335 • miami@edlen.com • www.edlen.com

CONFERENCE COURSES: JULY 13-15 | EXHIBIT HALL: JULY 15-17 | CONFERENCE CLASSES: JULY 16-17



BROWARD COUNTY CONVENTION CENTER

PRODUCED BY AIRBORNE PUBLIC SAFETY ASSOCIATION, INC.

DESCRIPTION	QTY	SHOW RATE	TOTAL
VIDEO AND COMPUTER DISPLAY			
27" Data Monitor with Table Stand - No Audio Speakers		\$	
32" Display Monitor with Table Stand, Built In Speakers and USB		\$	
43" Display Monitor with Table Stand, Built In Speakers and USB		\$	
55" Display Monitor with Table Stand, Built In Speakers and USB		\$	
65" Display Monitor with Table Stand, Built In Speakers and USB		\$	
72" Floor Stand for 32" to 60" Monitor with Order Above (Includes Mounting Brackets)		\$	
Shelf for 72" Floor Stand		\$	
Wall Mount Bracket for up to 32" Monitor with Order Above		\$	
Wall Mount Bracket for up to 65" Monitor with Order Above		\$	
Wall Mount Bracket without Display Monitor Order without Order Above		\$	
HDMI Computer Adapter		\$	
HD Media Player		\$	
DESKTOP and LAPTOP COMPUTER with Windows 11 and Office 2021			
Desktop - 3.0 GHZ, 4 GB RAM, 160 GB HD and 17" LCD Flat Panel Monitor		\$	
Laptop - 3.3 GHZ, 32 GB RAM, 1TB HD		\$	
COMPUTER EQUIPMENT			
HP Laser Printer		\$	
Computer Speakers		\$	
Wireless Keyboard and Mouse		\$	
PROJECTION			
LCD Support Package (6'0" Screen, Cart and Cables)		\$	
HD Projector 5k Lumens		\$	
HD Projector 7k Lumens		\$	
AUDIO			
Pro Digital Wireless Handheld Microphone with Floor Stand		\$	
Pro Digital Wireless Lavalier Microphone		\$	
Audio Mixer Board		\$	
Sound System: Speakers, Stands and Audio Mixer (Small = 0-50 people)		\$	
Sound System: Speakers, Stands and Audio Mixer (Large = 50-100 people)		\$	
Computer Audio Interface with Audio Order, Above		\$	
Equipment Total:			

PLEASE COMPLETE BOTH SIDES



BROWARD COUNTY CONVENTION CENTER

PRODUCED BY AIRBORNE PUBLIC SAFETY ASSOCIATION, INC.

Equipment Sub-Total From Page 1:	<input type="text"/>
Handling Charge = 25% of Equipment Total or Minimum \$175.00	<input type="text"/>
TOTAL CHARGES:	<input type="text"/>

On-Site Information:

Contact _____ Cell Phone _____ Delivery Booth Location _____

Delivery Date _____ Delivery Time _____ Pick-Up Date _____ Pick-up Time _____

Billing Information:

Company _____ Contact _____ Order Date _____

Address _____ City _____ State _____ Zip Code _____

Phone # _____ Fax # _____ Email _____

Payment Information:

Enter Card Below Send Payment Link

Card Type _____ Card # _____ Exp. Date _____ CVV# _____

Name on Card _____ Signature of Cardholder _____

Cardholder Address _____ City _____ State _____ Zip _____

Terms and Conditions:

Full Payment must be submitted with order to guarantee equipment.

Orders received after deadline date will incur a 15% rate increase.

DEADLINE DATE IS JUNE 13, 2026

Cancellations made 15 days prior to delivery date are subject to a 30% cancelation charge.

Cancellations made 7 days prior to delivery date are subject to a 100% cancelation charge.

Customer is responsible for the safe return of equipment and will be billed for any damages or loss to equipment.

Customer must be present to sign for delivery and pick-up.

EMAIL ORDER TO: cody@avpg.com

"Thank You For Your Order"

SAVOR...
THE EXPERIENCE.

EXHIBITOR MENU



**BROWARD COUNTY
CONVENTION
CENTER**
GREATER FORT
LAUDERDALE



CONTENTS

- 3 WELCOME
- 4 GENERAL INFORMATION
- 6 BREAKFAST
- 9 NON-ALCOHOLIC BEVERAGES
- 13 BREAKS
- 16 BOXED LUNCHES
- 18 RECEPTIONS
- 22 ALCOHOLIC BEVERAGES



**BROWARD COUNTY
CONVENTION
CENTER**
GREATER FORT
LAUDERDALE

LOCAL VENDORS

As part of our commitment to supporting the surrounding business community we are proud to partner with many local suppliers including:

MICROGREENS AND PRODUCE

Harpke Family Farm
harpkefamilyfarm.com

Mr. Greens
mrgreensproduce.com

SEAFOOD

Fish's Wholesale: Restaurant Quality Seafood
fishswholesale.com

BEVERAGES

Gulf Stream Brewery and Pizzeria
gulfstreambeer.com

BARISTA SERVICES

Express Kafeh
expresskafeh.com

DESSERTS

Pastry Is Art: Bakery & Coffee Shop
pastryisart.com

KITCHEN WASTE / RECYCLING

Renuable Composting & Landscaping
liverenuable.com



**BROWARD COUNTY
CONVENTION
CENTER** GREATER FORT
LAUDERDALE

WELCOME TO SAVOR

EXPERIENCES & SUSTAINABILITY

OUR MISSION

Our mission is to enrich guest experience, building upon your vision through food – listening, learning, growing, harvesting, cooking and breaking bread together.

At SAVOR, we aspire to design a visitor experience so inclusive, so delicious, and so incredible that it will live as your signature food offering for years to come.

Curating stories through food creates a powerful bond between people, place and time. And in an instant, a flavor, a taste or a familiar aroma transports us all to a memory—a snapshot in time with family and friends. That is the power of food. We strive to build on those moments.

We seek out partnerships with local chefs, restaurateurs and farmers, who will help us shape a singular dining experience known only at your venue, set within the unique backdrop of your community.

We showcase who we are by focusing on where we are and customizing experiences.

SUSTAINABILITY

Our sustainability initiatives include purchasing locally produced and sustainably raised products, sourcing sustainable seafood, using non-petroleum-based products, and recycling and composting our waste whenever possible.

ALLERGENS & FOOD SAFETY

We are focused on providing an inclusive environment to all your attendees. Whether your guests have a food allergy, food intolerance or dietary preference such as a vegan or vegetarian, our teams are trained and our menus are tailored to meet your needs.

Our Sales Team, Chefs and Managers have all taken and passed a ServSafe Allergen course and understand how to prepare safe food for your guests. We will offer the best in guidance and suggestions to provide a safe and welcoming dining environment for your event.

Speak with your Sales Representative about any anticipated dietary concerns as early as possible to ensure the most seamless service.

Look for these labels throughout the menu:



GLUTEN
FREE



VEGETARIAN



VEGAN



NUT
FREE



DAIRY
FREE

GENERAL INFORMATION

Savor...Fort Lauderdale is the exclusive food and beverage provider at the Broward County Convention Center. No food or beverage of any kind will be permitted to be brought into the facilities by the patron or any of the patron's guests or invitees. Food items may not be taken off the premises; however, excess prepared food is donated under regulated conditions to agencies feeding the underprivileged.

MENUS

Menu selections and other details pertinent to your functions are required to be submitted to the catering department a minimum of six weeks prior to the first function date. Our culinary team is happy to customize the perfect menu for your event.

RAW FOOD DISCLAIMER

Consuming raw or undercooked meats, poultry, seafood, shellfish, or eggs may increase your risk of foodborne illness, especially if you have certain medical conditions.

PRICING

Prices quoted do not include 24% administrative fee or 7% sales tax unless otherwise noted. Prices are subject to change without notice; guaranteed prices will be confirmed when contracted.

SERVICE CHARGE

A service charge, currently 24% is applied to all Food and Beverage Services. This service charge is subject to Florida State Sales Tax of 7%.

GUARANTEE

A guaranteed number of attendees/quantities of food is required. This guarantee must be submitted by noon five (5) business days before your event. If the guarantee is not received, SAVOR...Fort Lauderdale reserves the right to charge for the number of persons/quantities specified on the contracted event order. Cancellations and reductions of guarantee are subject to full charges within five (5) business days prior to event.

OVERSET POLICY

SAVOR...Fort Lauderdale will prepare an overage of 3% (up to 50 meals). Meals will be charged at full menu pricing, if used.

SERVICE STAFF

Guest to server ratio is 1 server per 20 guests for plated meal functions and 1 server per 40 guests at buffet functions. This is for service at rounds of ten. Rounds of less than ten guests or a request for additional staffing is subject to labor fees. Holiday labor rates will apply for events scheduled on building holidays.

EVENT TIMELINE

All service times are based on two-hour breakfast, lunch service and dinner service. Additional service time will be subject to additional labor fees. Event start or end times that deviate more than thirty minutes than contracted will have additional labor fees per hour, per server scheduled. Additional security and ancillary fees may also apply.

BEVERAGE SERVICES

Please note alcoholic beverages and service are regulated by the Liquor Control Board, SMG/SAVOR, as licensee, is responsible for the administration of these regulations: NO ALCOHOLIC BEVERAGES MAY BE BROUGHT ONTO THE PREMISE FROM OUTSIDE SOURCES; WE RESERVE THE RIGHT TO REFUSE ALCOHOL SERVICE TO INTOXICATED OR UNDERAGE PERSONS. NO ALCOHOLIC BEVERAGE CAN BE REMOVED FROM THE PREMISES.

CONTRACTS

A signed copy of the contract outlining all catering services will be provided. The signed contracts state terms, addendum, and specific function sheets constitute the entire agreement between the client and SAVOR...Fort Lauderdale. Secondary agents, acting on behalf of the primary client receiving services, may sign the contract in their behalf only with full payment in advance. Any changes, revisions, additions or deletions to the banquet contract and banquet event orders shall be in writing and signed by both parties.

CANCELLATIONS

Any event cancelled less than 3 business days prior to the event will incur 100% of the estimated charges. Please note, for specialty menus or items, a longer window of cancellation may be necessary, this is determined on an event by event basis.

PAYMENT/DEPOSIT

An initial deposit in the amount noted on the Catering Contract is payable, along with a signed contract, at the specified date on the contract letter to guarantee catering services. Full payment of the balance due is payable 14 business days prior to the event. Payment can be made in check, ACH or wire transfer. For additions, a major credit card is required to guarantee payment of any replenishment or new orders requested during a show/function. These charges will be billed to the credit card unless payment is received at the end of the show/function.

ALLERGIES

SAVOR...Fort Lauderdale facilities are not certified Gluten Free, Nut Free or Vegan. We cannot guarantee that cross contact with allergens will not occur and cannot assume any responsibility or liability for a person's sensitivity or allergy to any food item provided in our facility.



ALL THE AFOREMENTIONED POLICIES WILL BE STRICTLY ADMINISTERED. ANY VIOLATION OF THESE WILL RESULT IN THE REMOVAL OF PRODUCT FROM THE SHOW FLOOR

EXHIBITOR FLOOR CATERING THAT REQUIRES POWER, MUST HAVE A DEDICATED POWER SUPPLY.

BREAKFAST START YOUR DAY

A LA CARTE • BOXED



**BROWARD COUNTY
CONVENTION
CENTER** GREATER FORT
LAUDERDALE



BREAKFAST A LA CARTE

Minimum 25 guests.

BAGEL STATION | 12 per guest

Assorted bagels with plain, vegetable, smoked salmon cream cheeses, honey butter, fruit preserves

*Toaster provided, 110v/20amp
Client responsible for power in booths.*

ASSORTED ARTISAN BREAD STATION | 10 per guest

Assorted artisan breads, whipped honey butters, fruit preserves

MARINATED FRUIT PARISIENNE | 6 ea.

Fresh fruit marinated with lime juice, mint, spices

FRUIT & YOGURT PARFAIT | 8 ea.

Mixed berry, vanilla Greek yogurt parfait, crunchy raisin granola
OR

Kiwi & papaya, ginger yogurt parfait, spicy candied peanuts

Minimum 25 per selection.

BREAKFAST SANDWICHES | 10 ea.

Egg & cheese on toasted English muffin or buttery croissant

With your choice of one: bacon, sausage, or Canadian bacon

Eggs, balsamic onion jam and vintage Canadian cheddar on grilled challah 

Minimum 25 per selection.

EGGS BENEDICT TRADITIONAL | 10 ea.

Poached egg, Canadian bacon, hollandaise sauce

With jumbo lump crab meat, blood orange hollandaise | 14 ea.

With smoked salmon, horseradish dill hollandaise | 12 ea.

With braised short rib, blistered tomato hollandaise | 14 ea.

With marinated avocado, chili lime hollandaise  | 14 ea.

[Plant-based jalapeño salmon cake, vegan hollandaise  | 16 ea.]

Substitute English muffin with hash brown on any Benedict for a GF option for an additional \$3 each.

Minimum 25 per selection.

Chef attendant required at \$180 each, 2 hour maximum, 1 chef per 75 guests.



BREAKFAST BURRITOS

Served with marinated avocado, roasted tomato salsa, & sour cream

Minimum 25 per selection.

Scrambled eggs, Mexican chorizo, peppers & onions, cotija cheese, flour tortilla | 11 ea.

Scrambled eggs, bacon, asparagus, gruyere cheese, flour tortilla | 11 ea.

[Plant-based scrambled "eggs" & plant-based chorizo, spinach, peppers, whole wheat tortilla  | 12 ea.]

OMELET STATION | 14 per guest

Farm fresh eggs, with ham, chorizo, bacon, sausage, smoked salmon, onions, peppers, tomatoes, spinach, mushrooms, assorted cheeses

[Plant-based chorizo and plant-based meat ball ]

Chef attendant required at \$180 each, 2 hour maximum, 1 chef per 75 guests.

*See page 13 for
Boxed Breakfast options.*

BEVERAGES

HOT, COLD & REFRESHING

HOT BEVERAGES • SOFT DRINKS • INFUSED WATER • BARISTA PACKAGES



BEVERAGES

COLD

By the case, per dozen.

ASSORTMENT OF SODA | 48

Coke, Coke Zero, Diet Coke, Sprite

CANNED WATER | 60

BOTTLED TEA | 60

INDIVIDUAL BOTTLED FRUIT JUICES | 60

BOTTLED PERRIER SPARKLING WATER | 60

MONSTER ENERGY DRINK 16 OZ. | 96

Minimum 3 gallons per beverage selection.

ICED TEA | 45 per gal.

LEMONADE | 45 per gal.

FLORIDA ORANGE JUICE | 55 per gal.

INFUSED SPRING WATER | 120 per 3 gallons

Choice of: Lemon, Lime, Orange or Cucumber-Mint

WATER COOLER KIT | 150

Chilled water dispenser includes 5 gallons of spring water and disposable 7oz cups each.

5 gallon Water Refills \$50

Proudly serving Coca-Cola products.

Prices do not include a 24% administrative fee and 7% sales tax. Prices subject to change.

 Gluten Free  Vegetarian  Vegan  Nut Free  Dairy Free



**BROWARD COUNTY
CONVENTION
CENTER** | GREATER FORT
LAUDERDALE

October 2024



HOT

*One gallon is approximately 10-12 drinks.
Minimum of 3 gallons per hot beverages selection.*

FRESHLY BREWED LAVAZZA COFFEE | 65 per gal.

FRESHLY BREWED LAVAZZA DECAF COFFEE | 65 per gal.

ASSORTED TEAS WITH HOT WATER | 65 per gal.

LUXE COFFEE SERVICE | 80 per gal.

Enhance your hot beverage with local honey, a variety of flavored syrups, sugar sticks, Swiss Miss hot chocolate and marshmallows

SELF-SERVE COFFEE MACHINE

LAVAZZA COFFEE | 420

Refills \$325

Freshly brewed beverages from our Lavazza Coffee Machine. Kit includes 3-gallons of water, 36 regular coffee pods, 20 double shots, 12 decaf coffee pods, assorted teas with appropriate condiments and compostable cups.

Note: Requires dedicated 110v, 20amp electrical service - client's responsibility to supply .

KEURIG COFFEE | 350

Refills \$235

Add an extra touch to your coffee with freshly brewed beverages from your Keurig machine. Kit includes 3-gallons of water, 36 regular coffee pods, 12 decaf coffee pods and a selection of teas with appropriate condiments and compostable cups.

Note: Requires dedicated 110v, 20amp electrical service - client's responsibility to supply .

Prices do not include a 24% administrative fee and 7% sales tax. Prices subject to change.

 Gluten Free  Vegetarian  Vegan  Nut Free  Dairy Free

BARISTA PACKAGES

BY EXPRESS KAFEH

BARISTA HALF DAY PACKAGE | 2,000

Gourmet, locally roasted, Arabica & Decaf Espresso beans.

BEVERAGES

Espresso, Cappuccino, Caramel Macchiato, Café Mocha, Café Late, Cubano, Americano and Hot Chocolate. (4 hour / 300 cups)

SYRUPS

Vanilla, caramel, hazelnut, sugar-free options

Espresso machine and grinder

Coffee Cart *(subject to availability)*

Includes one trained Barista.

Requires 110 volts / 20 amp.

Client is responsible for electrical requirements.

*Additional cups over package size,
and within time limit: \$5.25++ each*

Barista Ripples Printer | 350

Ripples® printer to put logo on your beverages



BARISTA FULL DAY PACKAGE | 3,250

Gourmet, locally roasted, Arabica & Decaf Espresso beans.

BEVERAGES

Espresso, Cappuccino, Caramel Macchiato, Café Mocha, Café Late, Cubano, Americano and Hot Chocolate. (8 hour / 550 cups)

SYRUPS

Vanilla, caramel, hazelnut, sugar-free options

Espresso machine and grinder

Coffee Cart *(subject to availability)*

Includes one trained Barista.

Requires 110 volts / 20 amp.

Client is responsible for electrical requirements.

*Additional cups over package size,
and within time limit: \$5.25++ each*

Barista Ripples Printer | Included

Ripples® printer to put logo on your beverages

ENHANCEMENTS

Custom logo branded cups, sleeves, napkins and coffee cart.

Contact your Catering Sales Manager for more information.

6 week lead time for creation.

Prices do not include a 24% administrative fee and 7% sales tax. Prices subject to change.

Gluten Free

Vegetarian

Vegan

Nut Free

Dairy Free

October 2024





BREAKS TIME TO RECHARGE

A LA CARTE • ENHANCEMENTS • BOXED LUNCHES



**BROWARD COUNTY
CONVENTION
CENTER** GREATER FORT
LAUDERDALE

BREAKS A LA CARTE

Breaks are designed for in-booth disposable service.

SLICED FRUIT DISPLAY | 9 per guest

Minimum 25 guests (\$225)

ASSORTED BAKED

BAGELS, CREAM CHEESE SPREAD | 54 per doz.

ASSORTED BAKED MUFFINS | 54 per doz.

ASSORTED BREAKFAST PASTRIES | 54 per doz.

JUMBO BUTTER CROISSANTS | 56 per doz.

with honey butter and fruit preserves

MINI CHOCOLATE CROISSANT | 54 per doz.

JUMBO CINNAMON BUNS | 60 per doz.

ASSORTED HOMEMADE COOKIES | 50 per doz.

MIXED BERRY FILLED

BEIGNETS, SPICED CONDENSED MILK DIP | 54 per doz.

ASSORTED FRUIT YOGURT | 60 per doz.

WHOLE FRESH FRUIT | 50 per doz.

INDIVIDUAL BAGS OF MISS VICKIE'S CHIPS™ | 52 per doz.

TROPICAL FRUIT & NUTS | 52 per doz.

INDIVIDUAL NUTS & CHOCOLATE TRAIL MIX | 52 per doz.

GRANOLA BARS | 50 per doz.



BOXED BREAKFASTS

*All boxed breakfasts include condiments & cutlery.
Beverage not included. Minimum 25 per selection.*

CROISSANTS & BLUEBERRY MUFFIN, TEA BREAD, HARD-BOILED EGG, WHIPPED BUTTER, FRUIT PRESERVES | 24

MANGO GINGER SCONES, INDIVIDUAL VANILLA GREEK YOGURT, HARD-BOILED EGG, FRUIT PRESERVES | 24

CINNAMON BUNS, MIXED BERRY SALAD, SALTED MIXED NUTS, HARD-BOILED EGG | 24

SMOKED SALMON, PLAIN BAGEL, CREAM CHEESE, SUN DRIED TOMATO & CAPER TAPENADE, HARD-BOILED EGG, FRUIT SALAD | 26



Prices do not include a 24% administrative fee and 7% sales tax. Prices subject to change.

Gluten Free Vegetarian Vegan Nut Free Dairy Free

BREAK ENHANCEMENTS



POPCORN MACHINE | 300

Includes 200 servings.

Additional 50 servings | 125

Additional 200 servings | 250

Attendant Required | 180 ea. per 4 hours

Requires 110V / 20amp

COOKIE MACHINE | 475

Includes tongs, oven mitt & napkins.

Oatmeal, Chocolate Chip, Red Velvet and White Macadamia Nut

240 1.3oz cookies per case | 350

Attendant Required | 180 ea. per 4 hours

Requires 110V / 20amp

ICE CREAM CART

Minimum order 96 pieces.

Ice Cream

Blue Bunny Strawberry Shortcake, 24 per case | 137

Blue Bunny Chocolate Eclair, 24 per case | 130

Blue Ribbon Ice Cream Sandwich, 48 per case | 112

Blue Ribbon Fudge, 48 per case | 98

Häagen Daz®, 24 per case | 135

Non Alcohol - Pop Fusion®, 24 per case | 250
Blueberry Lemonade, Broward County "Citrus",
Florida Orange, Pineapple Mango, Strawberry

Alcohol - Pop Fusion®, 24 per case | 375
Blueberry Mojito, Florida Crush, Pina Colada,
Rum Runner, Strawberry Daiquiri

Rental | 175

Attendant Required | 180 ea. per 4 hours
Requires 110V / 20amp



Prices do not include a 24% administrative fee and 7% sales tax. Prices subject to change.

Gluten Free Vegetarian Vegan Nut Free Dairy Free

BOXED LUNCHES

All boxed lunches include pasta salad, Miss Vickie's™ chips, fresh baked cookie, whole fruit, condiments & cutlery. Beverage not included. Minimum 25 per selection.

BOXED LUNCHES | 36 per guest

Can be made gluten free upon request \$5.

HAM SANDWICH

Boar's Head™ Black Forest ham, balsamic caramelized onion, arugula, baby Swiss cheese, herb ciabatta

TURKEY BREAST SANDWICH

Boar's Head™ Sausalito turkey breast, smoked gouda, Gala apple chutney, bibb lettuce, brioche bun

ITALIAN SANDWICH

Boar's Head™ prosciutto, capicola, Genoa salami, provolone, Balsamic sun-dried tomato tapenade, fresh baked hoagie

ROAST BEEF SANDWICH

Boar's Head™ roast beef, grilled portobello mushroom, Red onion marmalade, sharp provolone, onion roll

VEGGIE SANDWICH

Grilled marinated eggplant & roasted pepper relish, fresh mozzarella, Romaine heart, ciabatta bread 🌱

GRILLED CHICKEN CAESAR SALAD

Hearts of romaine, shaved parmesan cheese, rosemary focaccia croutons, House Caesar dressing

CHEF SALAD

Boar's Head™ Black Forest ham, Oven Gold turkey, and Muenster cheese pinwheel, hard-boiled egg, European cucumber, baby heirloom tomato, rosemary focaccia croutons, marinated avocado, applewood smoked bacon, crisp field greens, buttermilk ranch dressing

ANCIENT GRAINS SALAD

Red & white quinoa, farro, barley, bulgar, edamame, chickpeas, baby heirloom tomato, Wild mushrooms, baby corn, charred radicchio 🌱
Orange ginger dressing 🌱

25 Guests: 3 Choices
25-100 Guests: 4 Choices
100+ Guests: 5 Choices



Prices do not include a 24% administrative fee and 7% sales tax. Prices subject to change.

Gluten Free Vegetarian Vegan Nut Free Dairy Free



RECEPTIONS BITES & STATIONS

HOT & COLD HORS D'OEUVRES • DISPLAYED STATIONS

RECEPTIONS

STATIONED HORS D'OEUVRES

Prices listed are per piece, minimum 25 per piece, disposable service. Passing labor \$180 minimum 4 hours. 1 server per 75 pieces.

COLD HORS D'OEUVRES

CRUDITE SHOOTER | 7

Roasted red pepper hummus 🍷 🌱

FRESH BERRIES, WHIPPED HERB GOAT CHEESE, FLORIDA KEYS HONEY, CROSTINI | 8 🌱

STRAWBERRY SHISO GAZPACHO | 7 🍷 🌱

AVOCADO TOAST | 6

Marinated avocado, baby heirloom tomato, pickled onion, cilantro 🌱

Add a quail egg | \$1 per piece

BEEF CARPACCIO | 9

Shaved Pecorino Romano, lemon cream, micro arugula

CHARRED SPICED HEIRLOOM CARROT | 8

Warm curry yogurt 🍷 🌱

TOMATO & MOZZARELLA SHOOTER | 8

Balsamic reduction, basil oil 🍷 🌱

SEARED DUCK BREAST | 10

White soy & ginger blackberry jam, toasted brioche

RED SNAPPER CRUDO | 10

Blood orange, white soy, mint, espelette puffed rice 🌱

SOY TRUFFLE TUNA TARTAR | 11

Sesame cone 🌱

KEY WEST PINK SHRIMP AGUA CHILE | 11

Charred orange, avocado mousse 🍷

CORVINA CEVICHE SHOOTERS | 11

Sweet potato, cancha, cilantro 🍷

BERRY SANGRIA POPSICLE | 14

Jamon Serrano, Manchego cheese 🍷
(contains alcohol less than 5% abv)

VEGAN "TUNA" CEVICHE | 11

Grilled corn & radish slaw, spicy cashew crunch 🍷 🌱

FILET MIGNON | 10

Whipped horseradish bleu cheese, micro citrus herbs, herb crostini

Prices do not include a 24% administrative fee and 7% sales tax. Prices subject to change.

🍷 Gluten Free 🌱 Vegetarian 🌱 Vegan 🍷 Nut Free 🌱 Dairy Free



October 2024

HOT HORS D'OEUVRES

Prices listed are per piece, minimum 25 per piece, disposable service. Passing labor \$180 minimum 4 hours. 1 server per 75 pieces.

WILD MUSHROOM POLENTA CAKE | 8

Piperade, micro chervil 🍷 🌱

QUINOA AND ZUCCHINI FRITTER | 9

Aji amarillo puree 🌱

SMOKED CHICKEN QUESADILLA CONE | 8

Chipotle herb aioli

TRUFFLE YUKON GOLD POTATO CROQUETTE | 7

Lemon crème fraîche 🌱

Enhance with caviar for additional \$2 per piece

MARYLAND CRAB CAKE | 9

Chive lime mustard sauce

PLANTAIN CHIP CRUSTED SHRIMP | 9

Sour orange mojo marmalade 🍷 🌱

BUFFALO CHICKEN SPRING ROLL | 8

Soy blue cheese

BRAISED SHORT RIB POT PIE | 9

Sriracha kewpie mayo, cilantro

RICE KRISPY CRUSTED TEMPURA SHRIMP | 9

Mango brown butter

PLANT-BASED MEATBALLS | 10

Bao bun, hoisin glaze, cilantro slaw 🌱

CORN & EDAMAME QUESADILLA | 8

Avocado crema, cotija 🌱

SMOKED PAPRIKA BRAISED CHICKEN | 9

Green chile arepa, guasacaca sauce 🍷

PLANT-BASED CHORIZO AL PASTOR TACO | 10

Pineapple salsa, cilantro 🍷 🌱

CHICKEN & FONTINA PARMIGIANO | 9

Sun-dried tomato marinara

CHAR SIU BAO (BBQ PORK BUN) | 9

Hoisin scallion sauce



Prices do not include a 24% administrative fee and 7% sales tax. Prices subject to change.

🍷 Gluten Free 🌱 Vegetarian 🌱 Vegan 🍷 Nut Free 🌱 Dairy Free



DISPLAYED STATIONS

Minimum 25 guests. Priced per person, disposable service.

CHARCUTERIE | 26

Artisan cured meats to include prosciutto, Genoa salami, soppressata, spicy capicola, wild boar salami, Finocchiona, pate campagne, duck pate en croûte, whole grain mustard, fig marmalade, cornichon, mixed olives, crackers, fresh assortment of crusty breads and gluten free offerings

ARTISAN CHEESE BOARD | 19

Chef's selection of domestic & imported cheeses, dried fruits, quince paste, fruit preserves, nuts crackers, flat breads, fresh baguette, and gluten friendly offerings

FARMER'S MARKET CRUDITÉ | 15

The season's freshest vegetables with house made dips, roasted garlic hummus, babaganoush, and Roquefort blue cheese

ROASTED VEGETABLE ANTIPASTO | 18

Colorful array of marinated & roasted vegetables to include squash, eggplant, wild mushrooms, tomato, peppers & seasonal offerings.

Pesto, balsamic reduction, Calabrese chili sauce, mixed olives, crackers, fresh assortment of crusty breads and gluten free offerings

TAPAS | 28

Contemporary Spanish-Style Tapas

Select three:

Beef, lamb, pork, chicken, calamari, salmon, or vegan.

Served with hummus, olives, assorted cheeses, marcona almonds, caperberries, grilled pita, and breads

Enhance with scallops, tuna, lobster or duck

As a substitute, \$5 per guest

As addition, \$12 per guest

SUSHI BAR | 8 per piece

250 piece minimum.

Assortment of traditional sushi, nigiri, and sashimi to include California rolls, shrimp tempura, spicy tuna, JB roll, 24-Carrot, Mighty Shroom vegan rolls.

Displayed in traditional Japanese sushi boats with soy sauce, wasabi, pickled ginger.

Enhance your event with a action sushi station!

Fully stocked display case with fresh fish

and sushi chef | \$50 per guest

Includes 2 hours of service

VIENNESE TABLE | 18

An assortment of miniature petit fours, cakes, mousses, seasonal desserts. Displayed with pate de fruit, macarons, chocolate truffles

Prices do not include a 24% administrative fee and 7% sales tax. Prices subject to change.

 Gluten Free  Vegetarian  Vegan  Nut Free  Dairy Free



October 2024



BEVERAGES BARS & COCKTAILS

LIQUOR • WINE • BEER • CRAFT COCKTAILS • HOSTED BARS





ALCOHOLIC BEVERAGES

Bartender fee of \$180 per four hours or portion thereof. Bar list and prices are subject to change.

HOSTED BARS BASED ON CONSUMPTION

Cost based on per drink consumption.

CAPTAINS BAR

SPIRITS BY THE COCKTAIL | 10

Vodka: New Amsterdam
Gin: New Amsterdam
Rum: Cruzan
Tequila: Sauza Hacienda
Scotch: Dewars
Bourbon: Jim Beam
Canadian Whiskey: Canadian Club
Irish Whiskey: Jameson Irish Whiskey

WINES BY THE GLASS | 9

Chardonnay: Woodbridge by R. Mondavi
Sauvignon Blanc: Woodbridge by R. Mondavi
Pinot Noir: Woodbridge by R. Mondavi
Red Blend: Apothic

COMMODORES BAR

SPIRITS BY THE COCKTAIL | 11

Vodka: Absolut
Gin: Bombay
Rum: Captain Morgan
Tequila: Jose Cuervo
Scotch: Johnny Walker Red
Bourbon: Marker's Mark, Jack Daniels
Canadian Whiskey: Seagram's VO
Irish Whiskey: Proper No. Twelve

WINES BY THE GLASS | 10

Chardonnay: Clos du Bois
Pinot Grigio: Ruffino Lumina
Pinot Noir: Mark West
Red Blend: The Dreaming Tree Crush

ADMIRALS BAR

SPIRITS BY THE COCKTAIL | 13

Vodka: Tito's
Gin: Hendricks
Rum: Sailor Jerry
Tequila: Hornito's
Scotch: Auchentoshan, Blacklabel
Bourbon: Knob Creek Bourbon, High West
Canadian Whiskey: Crown Royal
Irish Whiskey: Tullamore D.E.W

WINES BY THE GLASS | 12

Chardonnay: Sim Sonoma County
Sauvignon Blanc: Whitehaven
Pinot Noir: J Vineyards MultiAppellation
Red Blend: Unshackled by TPWC

** Products are subject to availability, substitute of equal or greater value.*

Prices do not include a 24% administrative fee and 7% sales tax. Prices subject to change.

 Gluten Free  Vegetarian  Vegan  Nut Free  Dairy Free



October 2024

NON-ALCHOLIC BEVERAGES

ASSORTMENT OF SODA | 4 ea.

Coke, Coke Zero, Diet Coke, Sprite

CANNED WATER | 5 ea.

BOTTLED TEA | 5 ea.

CANNED LEMONADE | 6 ea.

INDIVIDUAL BOTTLED FRUIT JUICES | 5 ea.

BOTTLED PERRIER SPARKLING WATER | 5 ea.

MONSTER ENERGY DRINK 16.OZ | 8 ea.

Proudly serving Coca-Cola products.

BEER & SELTZERS

AMERICAN PREMIUM BEER | 8 ea.

Bud Light, Michelob Ultra

IMPORTED BEER | 9 ea.

Heineken, Stella Artois

LOCAL CRAFT BEER | 9 ea.

Seasonal beer from Funky Buddha, Gold Coast and other regional brewers.

HARD SELTZER | 10 ea.

High Noon Sun Sips (Vodka Based Seltzer)

Flavors are subject to availability

MOCKTAILS

SPRING IN PARIS | 12 ea.

Blackberries, lime juice, grapefruit juice, lavender syrup, club soda, ice

RASMULE | 12 ea.

Raspberry fruit smash, simple syrup, lime juice, ginger beer, mint leaves, ice

PASSION FRUIT | 12 ea.

Passion fruit syrup, lime juice, tonic water, mint leaf, ice

COCONUT PARADISE | 12 ea.

Pineapple juice, orange juice, cream of coconut, lime juice, cinamon, garnished with nutmeg, pineapple and cherry



ORALE DRINK | 12 ea.

Peach or mango puree, orange juice, lime juice, ginger beer or ginger ale, tajin

GREEN DELIGHT | 12 ea.

Lime juice, simple syrup, ginger beer or club soda, red pepper, garnished with cucumber



Prices do not include a 24% administrative fee and 7% sales tax. Prices subject to change.

Gluten Free
 Vegetarian
 Vegan
 Nut Free
 Dairy Free



BAR ENHANCEMENTS

Minimum of 25 guests.

BLOODY MARY BAR

Choice of vodka, garnished with assorted hot sauce, skewered pickled vegetables, pickle spears & celery sticks

Amsterdam | 11

Absolut | 13

Titos | 15

SPARKLING MIMOSA BAR

Champagne or sparkling water served with your choice of fruit garnishes juices to include range, grapefruit & cranberry juice with strawberry, grapes, mint leaves, lime & orange wheels as garnishes

William Wycliff | 11

Ruffino Prosecco | 13

J Vineyards CA Sparkling | 15

CUSTOM COCKTAILS

Margarita | 12 ea.

Mojito | 12 ea.

Old Fashioned | 12 ea.

Mai-Tai | 12 ea.

WOLF PACK CUSTOM COCKTAILS

Upgrade to the Wolf Pack and create your own Custom Cocktail.

Create your own:

Tom of Finland Vodka Tonic | 13

Mr. Pickles Gin and Tonic | 13

Puncher's Chance Old Fashioned | 13

Assortment of fresh & dehydrated fruit garnishes
Bartender Required | \$180 (Minimum 4 hours.)

SLUSHY MACHINE

Choose (1) Flavor | 150 per gal. (Minimum 2 gallons.)

Pina Colada

Strawberry Daiquiri

Margarita

Peach Daiquiri

Rental | \$150 per machine

Attendant Required | \$180 ea. (Minimum 4 hours.)

Requires 110V amp



Prices do not include a 24% administrative fee and 7% sales tax. Prices subject to change.

Gluten Free
 Vegetarian
 Vegan
 Nut Free
 Dairy Free



October 2024



WINE BY THE BOTTLE

Cost based on consumption per opened bottle.

BOTTLE HOUSE WINE

[CABERNET - CANYON ROAD | 45](#)

[RED BLEND - APOTHIC | 45](#)

[PINOT NOIR - WOODBRIDGE | 45](#)

[ROSE - WOODBRIDGE | 45](#)

[CHARDONNAY - WOODBRIDGE | 45](#)

[SAUVIGNON BLANC - WOODBRIDGE | 45](#)

[PINOT GRIGIO - CANYON ROAD | 45](#)

PROSECCO BY THE BOTTLE

[WILLIAM WYCLIF | 48](#)

[RUFFINO PROSECCO | 80](#)

[LA MARCA | 108](#)

[J VINEYARDS CA SPARKLING | 139](#)

BOTTLE PREMIUM WINE

[CHARDONNAY - SIMI SONOMA COUNTY | 60](#)

[SAUVIGNON BLANC - WHITEHAVEN | 60](#)

[PINOT GRIGIO - MASO CANALI | 60](#)

[ROSE - FLEUR DE MER PROVENCE | 60](#)

[CABERNET - SIMI SONOMA COUNTY | 60](#)

[RED BLEND - UNSHACKLED BY TPWC | 60](#)

[PINOT NOIR - J VINEYARDS MULTI-APPELLATION | 60](#)

CHAMPAGNE BY THE BOTTLE

[VEUVE CLICQUOT | 195](#)

Prices do not include a 24% administrative fee and 7% sales tax. Prices subject to change.

 Gluten Free  Vegetarian  Vegan  Nut Free  Dairy Free



BOTTOMS UP DRAFT BEER

Rental price \$225. Bartender required at \$180, minimum 4 hours.

DRAFT BEER SERVICE

16 oz. cups provided.

1/2 Keg: 62 16 oz. cups

Full Keg: 124 16 oz. cups

DOMESTIC BEER

Everyone Under the Sun | 360 half keg

Bud Light | 275 half keg / 550 full keg

Michelob Ultra | 415 half keg / 550 full keg

Miller Lite | 415 half keg / 550 full keg

IMPORT BEER

Heineken | 425 half keg / 950 full keg

Modelo | 525 half keg / 950 full keg

Stella | 425 half keg / 950 full keg

*Ask your catering sales manager about custom
branded magnets and specialty sized cups.*

Prices do not include a 24% administrative fee and 7% sales tax. Prices subject to change.

 Gluten Free  Vegetarian  Vegan  Nut Free  Dairy Free



October 2024



CONTACT INFORMATION

Broward County Convention Center, SAVOR

1950 Eisenhower Blvd
Fort Lauderdale, FL 33316

Phone Number: (954) 302-8822

Email: catering@ftlauderdalecc.com

SAVOR...



SAMPLE FOOD & BEVERAGE DISTRIBUTION AUTHORIZATION REQUEST

Savor SMG/ASM Global is pleased to be able to work with all requests, but unfortunately, no outside food or beverage is allowed within the Broward County Convention Center. Savor SMG/ASM Global is the exclusive provider of all food and beverage for the Broward County Convention Center and our liability insurance only allows for original manufacturer/producers to distribute food items (including bottled water). Your Catering Event Manager is happy to work with you to assist with any special requests. If you are the manufacturing/producing company and wish to sample your product, please fill out the following form. In addition you will need to supply your Certificate of Insurance naming the Convention Center, SMG/ASM Global and Broward County as Additionally Insured. Please wait for approval from the Catering Department. Please send to catering@ftlauderdalecc.com

REGULATIONS:

1. Items dispensed are limited to product manufacturer/producer/distributor of exhibiting firm.
2. All items are limited to sample size
 - A. Non-Alcoholic Beverages limited to maximum 4 oz. Container with 3 oz of product.
 - B. Alcoholic Beverage items limited to 2 oz serving of Beer & .5 oz serving of liquor/spirits. A SAVOR Bartender is required.
 - C. Food items limited to "bite size".
 - D. Food and/or beverage items used as traffic promoters (i.e. cookies, popcorn, coffee, bottled water, bar service, alcoholic beverages etc.) MUST be purchased from Catering Department.

Name of Event: _____

Company Name: _____

Contact: _____

Address: _____ State: _____ Zip Code: _____

Phone: _____ Fax: _____

Email: _____ Booth #: _____

1. Products you wish to sample:

2. How do you plan on sampling this product (i.e. trays, 4oz cups):

3. Please explain purpose of offering these samples:

Approved By: _____

(SAVOR Food & Beverage Director)

_____ (Date)



FIRE CODE & SAFETY REQUIREMENTS

All cooking exhibits shall comply with the following:

- One 20 BC fire extinguisher with current tag for each cooking device.
- Deep fryers must have lids and single well. FRYER requires a class "K" extinguisher
- Equipment shall be fueled by low heat source.
- Cooking surface shall be limited to 288 square inches.
- Cooking equipment is required 4 (four) feet from public or have physical barrier.
- Equipment must be on a non-combustible surface.
- Cooking equipment is required 2 (two) feet apart.
- Flamed proof treated materials are required:
Curtains, drapes, table cloths, etc.
- Butane canisters cannot exceed 16oz.
- **NO propane cooking tanks allowed inside the convention center.**
- Convention center's carpet surface must be protected if there are any food preparation and/or cooking demonstration.

City of Fort Lauderdale Fire Department
The Greater Fort Lauderdale/Broward County Convention Center

Signature required to confirm the above fire code and regulations have been reviewed:

_____ (Food Vendor Representative if Cooking On-Site is Applicable)

_____ (Date)